

# THERMAL MANAGEMENT PRODUCTS CATALOG

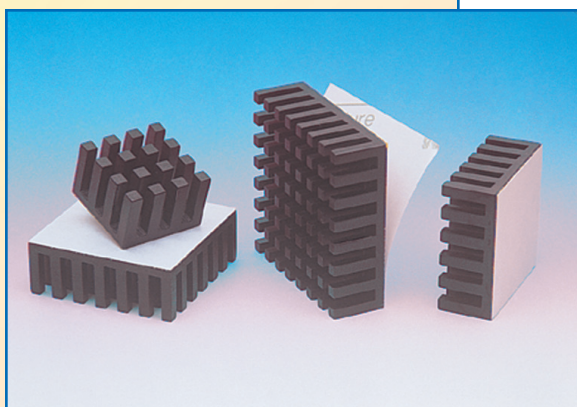
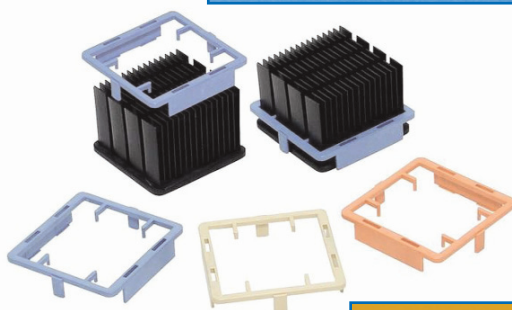
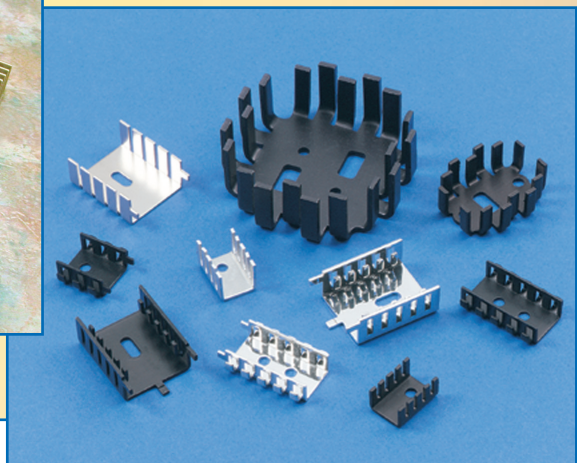
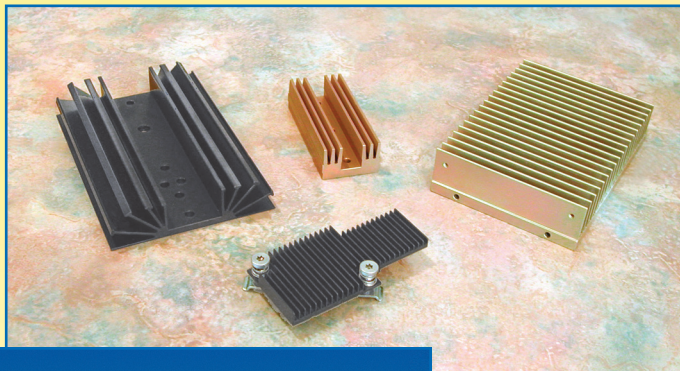

**TABLE OF CONTENTS**

	<u>PAGE</u>
<i>CORPORATE PROFILE</i> .....	2
<i>ADHESIVE PEEL AND STICK HEAT SINKS</i> .....	3
<i>FORGED HEAT SINKS WITH PLATE FINS</i> .....	4
<i>FORGED HEAT SINKS WITH PIN FINS</i> .....	6
<i>FORGED COPPER HEAT SINKS WITH PIN FINS</i> .....	7
<i>CLIP AND TAPE STYLES</i> .....	8
<i>STANDARD AND CUSTOM EXTRUSIONS</i> .....	9
<i>ADDITIONAL EXTRUDED PRODUCTS FOR TO-126, TO-202, TO-218 AND TO-220 TRANSISTORS</i> .....	10
<i>STANDARD ZIF CIRCUIT BOARD RETAINERS</i> .....	11
<i>ZIF III CIRCUIT BOARD RETAINERS</i> .....	14
<i>MACHINED ZIF ENCLOSURES</i> .....	16
<i>HEAT FRAMES, THERMAL LINKS AND FAN TOPS</i> .....	18
<i>THERMAL LINKS FOR TO-5, TO-8 AND TO-18 TRANSISTORS</i> .....	19
<i>HEAT SINKS FOR METAL AND PLASTIC CASE, CASE-MOUNTED SEMICONDUCTORS</i> .....	20
<i>BOARD-MOUNTED AND VERTICALLY MOUNTED HEAT SINKS WITH BOARD-MOUNTED TABS</i> .....	22
<i>BOARD AND VERTICALLY MOUNTED HEAT SINKS</i> .....	23

**CORPORATE PROFILE**

CTS Electronic Components is a division within CTS Corporation (NYSE: CTS), a leading designer and manufacturer of electronic components and a provider of electronics manufacturing services to OEMs in the automotive, computer, and telecommunications markets.

In 1997, CTS acquired Dynamics Corporation of America, the parent corporation of the former International Electronic Research Corporation (IERC). Since then, CTS has continued to develop, manufacture and market a quality line of standard and custom thermal management products and rugged circuit board retainers for the electronics and military industries.

Through the years, CTS has fine-tuned its business

systems to accommodate each customer's unique design and lead-time requirements.

CTS adds value to its customers through technical assistance during the design stage, quick prototype turnaround and dedicated manufacturing throughout the application lifecycle. CTS thermal management products are sold and supported through the CTS global network of manufacturer representatives, distributors and R&D facilities. We are pleased to offer new products to the marketplace and welcome the opportunity to serve you. Please visit us at [www.ctscorp.com](http://www.ctscorp.com) and then click on Components - Heat Sinks/Thermal Management Solutions and Circuit Board Retainers and Card Cages.

## ADHESIVE PEEL AND STICK HEAT SINKS

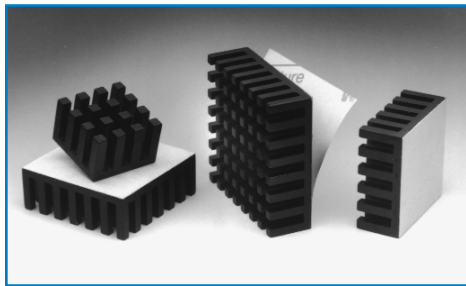

- With pre-applied adhesive, just peel off the release liner and press onto the component
- Reduces assembly costs; no more messy adhesives or greases required
- Excellent mechanical bond
- Thermally optimized pin fin
- Omnidirectional
- Adhesive shear strength at 100°C is 36psi (a one inch square heat sink would require a 36lb. force to remove heat sink)
- Applicable for BGA, PGA, PLCC, and QFP packages

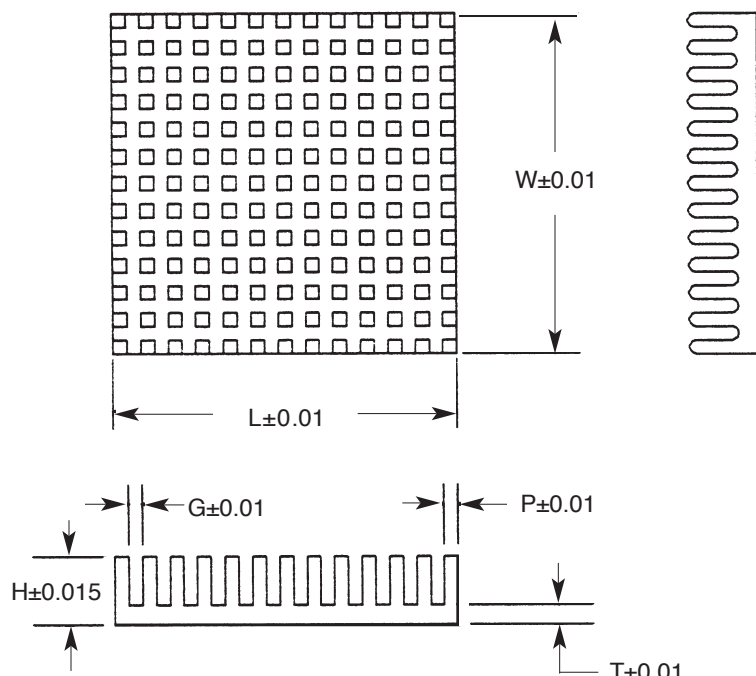

### HEAT SINK SPECIFICATIONS

HEAT SINK PART NUMBER***	SIZE				PIN FIN CONFIGURATION			THERMAL RESISTANCE CASE TO AMBIENT* °C/WATTS	
	(W)	(L)	(H)	T	P	G	FIN MATRIX	NATURAL CONVECTION**	FORCED CONVECTION @ 400 LFPM
BDN09-3CB/A01	0.91	0.91	.355	.09	.069	.072	7x7	26.9	9.6
BDN09-6CB/A01			.605	.10	.132	.128	4x4	24.5	7.7
BDN10-3CB/A01	1.01	1.01	.355	.09	.083	.072	7x7	26.4	8.0
BDN10-5CB/A01			.555	.10	.111	.114	5x5	20.8	6.3
BDN11-3CB/A01	1.11	1.11	.355	.09	.076	.072	8x8	20.9	7.2
BDN11-6CB/A01			.605	.10	.119	.128	5x5	18.5	5.7
BDN12-3CB/A01	1.21	1.21	.355	.09	.060	.081	9x9	19.6	6.8
BDN12-5CB/A01			.555	.10	.105	.114	6x6	16.5	5.2
BDN13-3CB/A01	1.31	1.31	.355	.09	.074	.081	9x9	16.1	6.0
BDN13-5CB/A01			.555	.10	.125	.114	6x6	14.9	4.7
BDN14-3CB/A01	1.41	1.41	.355	.09	.067	.081	10x10	16.2	5.6
BDN14-6CB/A01			.605	.10	.128	.128	6x6	13.1	4.2
BDN15-3CB/A01	1.51	1.51	.355	.09	.062	.081	11x11	15.1	4.5
BDN15-5CB/A01			.555	.10	.118	.114	7x7	11.9	3.8
BDN16-3CB/A01	1.61	1.61	.355	.09	.072	.081	11x11	13.5	4.5
BDN16-6CB/A01			.605	.10	.119	.128	7x7	10.6	3.5
BDN17-3CB/A01	1.71	1.71	.355	.09	.065	.072	13x13	11.5	3.8
BDN17-5CB/A01			.555	.10	.114	.114	8x8	9.5	3.2
BDN18-3CB/A01	1.81	1.81	.355	.09	.072	.072	13x13	10.8	3.5
BDN18-6CB/A01			.605	.10	.128	.114	8x8	8.1	2.8
BDN19-3CB/A01	1.91	1.91	.355	.09	.069	.072	14x14	9.9	2.9
BDN19-5CB/A01			.555	.10	.111	.114	9x9	7.8	2.7
BDN20-3CB/A01	2.01	2.01	.355	.09	.066	.072	15x15	9.1	2.8
BDN20-5CB/A01			.555	.10	.122	.114	9x9	7.2	2.5
BDN21-3CB/A01	2.11	2.11	.355	.09	.064	.072	16x16	8.5	2.6
BDN21-6CB/A01			.605	.10	.120	.128	9x9	6.5	2.2

NOTES:

\*Thermal resistance of adhesive tape is included.

\*\*Thermal resistance values based on power density of 3 watts/in.<sup>2</sup>

\*\*\*Part numbers listed for standard black anodized heat sinks with CTS adhesive tapes.

All dimensions are in inches.

**FORGED HEAT SINKS WITH PLATE FINS**

**DESIGN FEATURES**

- Precision forging technology for high power applications
- Designed for BGA and other surface mount packages
- Various mounting methods available
- Select from multiple fin heights

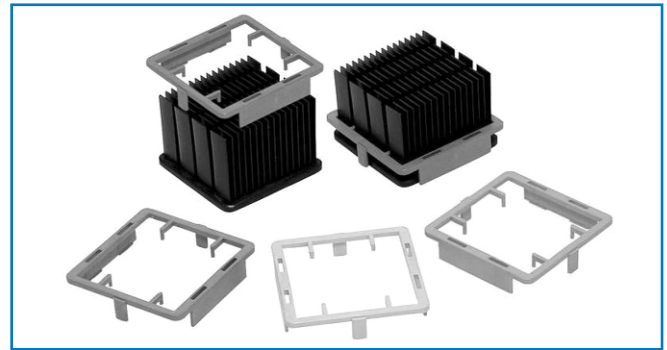
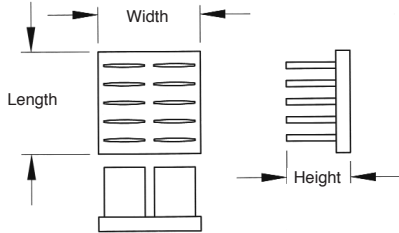

**PRODUCT BENEFITS**

- No special tools needed for assembly
- No additional holes required on the PCB
- Special clip easily snaps on and self-aligns

**SERIES APF LOW-PROFILE FORGED HEAT SINKS**

Part Number	Fin Matrix (Rows x Columns)	Length x Width x Height (mm)	Thermal Resistance (°C/Watt @ 200 LFPM)	Pressure Drop (inches of water)
APF19-19-06CB	12 x 2	19 x 19 x 6.3	7.1	0.033
APF19-19-10CB	12 x 2	19 x 19 x 9.5	5.3	0.033
APF19-19-13CB	12 x 2	19 x 19 x 12.7	4.0	0.033
APF30-30-06CB	19 x 3	30 x 30 x 6.3	4.4	0.039
APF30-30-10CB	19 x 3	30 x 30 x 9.5	3.3	0.039
APF30-30-13CB	19 x 3	30 x 30 x 12.7	2.5	0.039
APF40-40-06CB	26 x 4	40 x 40 x 6.3	3.3	0.043
APF40-40-10CB	26 x 4	40 x 40 x 9.5	2.5	0.043
APF40-40-13CB	26 x 4	40 x 40 x 12.7	1.9	0.043

**SERIES AER FORGED HEAT SINKS**

Part Number	Fin Matrix (Rows x Columns)	Length x Width x Height (mm)	Thermal Resistance (°C/Watt @ 200 LFPM)	Pressure Drop (inches of water)
AER19-19-12CB	2 x 6	18.6 x 18.6 x 11.6	7.2	0.017
AER19-19-15CB	2 x 6	18.6 x 18.6 x 14.6	6.6	0.017
AER19-19-18CB	2 x 6	18.6 x 18.6 x 17.6	5.4	0.017
AER19-19-21CB	2 x 6	18.6 x 18.6 x 20.6	4.7	0.017
AER19-19-23CB	2 x 6	18.6 x 18.6 x 22.6	4.3	0.017
AER19-19-28CB	2 x 6	18.6 x 18.6 x 27.6	3.8	0.017
AER19-19-33CB	2 x 6	18.6 x 18.6 x 32.6	3.3	0.017
AER21-21-12CB	2 x 7	20.6 x 20.6 x 11.6	7.2	0.017
AER21-21-15CB	2 x 7	20.6 x 20.6 x 14.6	6.6	0.017
AER21-21-18CB	2 x 7	20.6 x 20.6 x 17.6	5.4	0.017
AER21-21-21CB	2 x 7	20.6 x 20.6 x 20.6	4.7	0.017
AER21-21-23CB	2 x 7	20.6 x 20.6 x 22.6	4.3	0.017
AER21-21-28CB	2 x 7	20.6 x 20.6 x 27.6	3.8	0.017
AER21-21-33CB	2 x 7	20.6 x 20.6 x 32.6	3.3	0.017
AER23-23-12CB	2 x 8	22.6 x 22.6 x 11.6	6.2	0.018
AER23-23-15CB	2 x 8	22.6 x 22.6 x 14.6	5.4	0.018
AER23-23-18CB	2 x 8	22.6 x 22.6 x 17.6	4.4	0.018
AER23-23-21CB	2 x 8	22.6 x 22.6 x 20.6	3.8	0.018
AER23-23-23CB	2 x 8	22.6 x 22.6 x 22.6	3.5	0.018
AER23-23-28CB	2 x 8	22.6 x 22.6 x 27.6	3.1	0.018
AER23-23-33CB	2 x 8	22.6 x 22.6 x 32.6	2.7	0.018
AER25-25-12CB	3 x 9	24.6 x 24.6 x 11.6	5.3	0.020
AER25-25-15CB	3 x 9	24.6 x 24.6 x 14.6	4.6	0.020
AER25-25-18CB	3 x 9	24.6 x 24.6 x 17.6	3.8	0.020
AER25-25-21CB	3 x 9	24.6 x 24.6 x 20.6	3.3	0.020
AER25-25-23CB	3 x 9	24.6 x 24.6 x 22.6	3.0	0.020
AER25-25-28CB	3 x 9	24.6 x 24.6 x 27.6	2.7	0.020
AER25-25-33CB	3 x 9	24.6 x 24.6 x 32.6	2.4	0.020

**MATERIAL:** 6063 Aluminum Alloy, Black Anodized

## SERIES AER FORGED HEAT SINKS

Part Number	Fin Matrix (Rows x Columns)	Length x Width x Height (mm)	Thermal Resistance (°C/Watt @ 200 LFPM)	Pressure Drop (inches of water)
AER27-27-12CB	3 x 9	26.6 x 26.6 x 11.6	5.2	0.020
AER27-27-15CB	3 x 9	26.6 x 26.6 x 14.6	4.5	0.020
AER27-27-18CB	3 x 9	26.6 x 26.6 x 17.6	3.7	0.020
AER27-27-21CB	3 x 9	26.6 x 26.6 x 20.6	3.1	0.020
AER27-27-23CB	3 x 9	26.6 x 26.6 x 22.6	2.9	0.020
AER27-27-28CB	3 x 9	26.6 x 26.6 x 27.6	2.7	0.020
AER27-27-33CB	3 x 9	26.6 x 26.6 x 32.6	2.3	0.020
AER29-29-12CB	3 x 9	28.6 x 28.6 x 11.6	4.4	0.020
AER29-29-15CB	3 x 9	28.6 x 28.6 x 14.6	3.8	0.020
AER29-29-18CB	3 x 9	28.6 x 28.6 x 17.6	3.2	0.020
AER29-29-21CB	3 x 9	28.6 x 28.6 x 20.6	2.7	0.020
AER29-29-23CB	3 x 9	28.6 x 28.6 x 22.6	2.5	0.020
AER29-29-28CB	3 x 9	28.6 x 28.6 x 27.6	2.4	0.020
AER29-29-33CB	3 x 9	28.6 x 28.6 x 32.6	2.2	0.020
AER31-31-12CB	3 x 11	30.6 x 30.6 x 11.6	3.4	0.014
AER31-31-15CB	3 x 11	30.6 x 30.6 x 14.6	3.3	0.014
AER31-31-18CB	3 x 11	30.6 x 30.6 x 17.6	2.7	0.014
AER31-31-21CB	3 x 11	30.6 x 30.6 x 20.6	2.3	0.014
AER31-31-23CB	3 x 11	30.6 x 30.6 x 22.6	2.1	0.014
AER31-31-28CB	3 x 11	30.6 x 30.6 x 27.6	1.9	0.014
AER31-31-33CB	3 x 11	30.6 x 30.6 x 32.6	1.7	0.014
AER33-33-12CB	3 x 11	32.6 x 32.6 x 11.6	3.4	0.012
AER33-33-15CB	3 x 11	32.6 x 32.6 x 14.6	2.9	0.012
AER33-33-18CB	3 x 11	32.6 x 32.6 x 17.6	2.4	0.012
AER33-33-21CB	3 x 11	32.6 x 32.6 x 20.6	1.9	0.012
AER33-33-23CB	3 x 11	32.6 x 32.6 x 22.6	1.7	0.012
AER33-33-28CB	3 x 11	32.6 x 32.6 x 27.6	1.5	0.012
AER33-33-33CB	3 x 11	32.6 x 32.6 x 32.6	1.3	0.012
AER35-35-12CB	4 x 12	34.6 x 34.6 x 11.6	3.3	0.018
AER35-35-15CB	4 x 12	34.6 x 34.6 x 14.6	2.9	0.018
AER35-35-18CB	4 x 12	34.6 x 34.6 x 17.6	2.4	0.018
AER35-35-21CB	4 x 12	34.6 x 34.6 x 20.6	2.1	0.018
AER35-35-23CB	4 x 12	34.6 x 34.6 x 22.6	1.8	0.018
AER35-35-28CB	4 x 12	34.6 x 34.6 x 27.6	1.5	0.018
AER35-35-33CB	4 x 12	34.6 x 34.6 x 32.6	1.3	0.018
AER38-38-12CB	4 x 13	37.1 x 37.1 x 11.6	3.2	0.025
AER38-38-15CB	4 x 13	37.1 x 37.1 x 14.6	2.7	0.025
AER38-38-18CB	4 x 13	37.1 x 37.1 x 17.6	2.2	0.025
AER38-38-21CB	4 x 13	37.1 x 37.1 x 20.6	1.9	0.025
AER38-38-23CB	4 x 13	37.1 x 37.1 x 22.6	1.8	0.025
AER38-38-28CB	4 x 13	37.1 x 37.1 x 27.6	1.5	0.025
AER38-38-33CB	4 x 13	37.1 x 37.1 x 32.6	1.3	0.025
AER40-40-12CB	4 x 14	39.6 x 39.6 x 11.6	2.6	0.026
AER40-40-15CB	4 x 14	39.6 x 39.6 x 14.6	2.4	0.026
AER40-40-18CB	4 x 14	39.6 x 39.6 x 17.6	1.9	0.026
AER40-40-21CB	4 x 14	39.6 x 39.6 x 20.6	1.7	0.026
AER40-40-23CB	4 x 14	39.6 x 39.6 x 22.6	1.5	0.026
AER40-40-28CB	4 x 14	39.6 x 39.6 x 27.6	1.4	0.026
AER40-40-33CB	4 x 14	39.6 x 39.6 x 32.6	1.2	0.026
AER43-43-12CB	4 x 15	42.1 x 42.1 x 11.6	2.4	0.027
AER43-43-15CB	4 x 15	42.1 x 42.1 x 14.6	2.1	0.027
AER43-43-18CB	4 x 15	42.1 x 42.1 x 17.6	1.7	0.027
AER43-43-21CB	4 x 15	42.1 x 42.1 x 20.6	1.5	0.027
AER43-43-23CB	4 x 15	42.1 x 42.1 x 22.6	1.3	0.027
AER43-43-28CB	4 x 15	42.1 x 42.1 x 27.6	1.2	0.027
AER43-43-33CB	4 x 15	42.1 x 42.1 x 32.6	1.1	0.027
AER45-45-12CB	4 x 16	44.6 x 44.6 x 11.6	2.3	0.020
AER45-45-15CB	4 x 16	44.6 x 44.6 x 14.6	1.9	0.020
AER45-45-18CB	4 x 16	44.6 x 44.6 x 17.6	1.6	0.020
AER45-45-21CB	4 x 16	44.6 x 44.6 x 20.6	1.4	0.020
AER45-45-23CB	4 x 16	44.6 x 44.6 x 22.6	1.2	0.020
AER45-45-28CB	4 x 16	44.6 x 44.6 x 27.6	1.1	0.020
AER45-45-33CB	4 x 16	44.6 x 44.6 x 32.6	0.9	0.020

**MATERIAL:** 6063 Aluminum Alloy, Black Anodized

**FORGED HEAT SINKS WITH PIN FINS**

**DESIGN FEATURES**

- Precision forging technology for high power applications
- Omnidirectional pins
- Designed for BGA and other surface mount packages
- Various mounting methods available
- Select from multiple fin heights

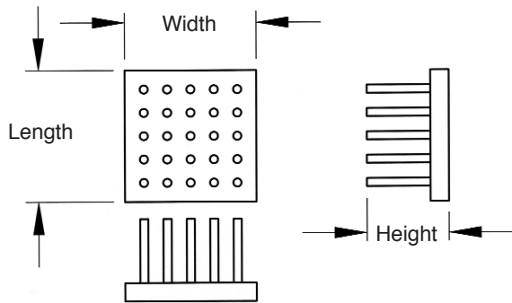
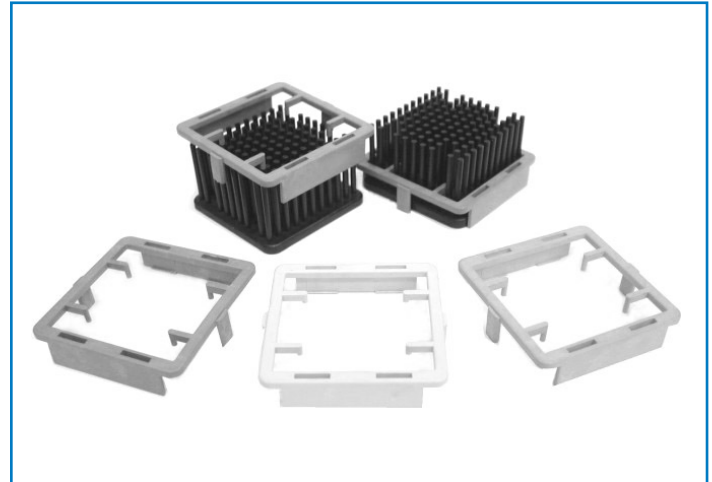

**PRODUCT BENEFITS**

- No special tools needed for assembly
- No additional holes required on the PCB
- Special clip easily snaps on and self-aligns

**SERIES APR FORGED ALUMINUM HEAT SINKS WITH PIN FINS**

Part Number	Fin Matrix (Rows x Columns)	Length x Width x Height (mm)	Thermal Resistance (°C/Watt @ 200 LFPM)	Pressure Drop (inches of water)
APR19-19-12CB	5 x 5	18.6 x 18.6 x 11.6	7.7	0.013
APR19-19-15CB	5 x 5	18.6 x 18.6 x 14.6	7.4	0.013
APR19-19-20CB	5 x 5	18.6 x 18.6 x 19.6	4.9	0.013
APR19-19-25CB	5 x 5	18.6 x 18.6 x 24.6	4.6	0.013
APR27-27-12CB	8 x 8	26.6 x 26.6 x 11.6	5.3	0.015
APR27-27-15CB	8 x 8	26.6 x 26.6 x 14.6	4.4	0.015
APR27-27-20CB	8 x 8	26.6 x 26.6 x 19.6	3.1	0.015
APR27-27-25CB	8 x 8	26.6 x 26.6 x 24.6	2.8	0.015
APR29-29-12CB	8 x 8	28.6 x 28.6 x 11.6	3.9	0.018
APR29-29-15CB	8 x 8	28.6 x 28.6 x 14.6	3.7	0.018
APR29-29-20CB	8 x 8	28.6 x 28.6 x 19.6	2.6	0.018
APR29-29-25CB	8 x 8	28.6 x 28.6 x 24.6	2.5	0.018
APR33-33-12CB	9 x 9	32.6 x 32.6 x 11.6	3.8	0.020
APR33-33-15CB	9 x 9	32.6 x 32.6 x 14.6	3.2	0.020
APR33-33-20CB	9 x 9	32.6 x 32.6 x 19.6	2.4	0.020
APR33-33-25CB	9 x 9	32.6 x 32.6 x 24.6	1.9	0.020
APR35-35-12CB	10 x 10	34.7 x 34.7 x 11.6	3.5	0.022
APR35-35-15CB	10 x 10	34.7 x 34.7 x 14.6	2.9	0.022
APR35-35-20CB	10 x 10	34.7 x 34.7 x 19.6	2.0	0.022
APR35-35-25CB	10 x 10	34.7 x 34.7 x 24.6	1.8	0.022
APR38-38-12CB	11 x 11	37.1 x 37.1 x 11.6	3.3	0.025
APR38-38-15CB	11 x 11	37.1 x 37.1 x 14.6	2.7	0.025
APR38-38-20CB	11 x 11	37.1 x 37.1 x 19.6	1.9	0.025
APR38-38-25CB	11 x 11	37.1 x 37.1 x 24.6	1.5	0.025
APR40-40-12CB	11 x 11	39.6 x 39.6 x 11.6	2.8	0.027
APR40-40-15CB	11 x 11	39.6 x 39.6 x 14.6	2.3	0.027
APR40-40-20CB	11 x 11	39.6 x 39.6 x 19.6	1.6	0.027
APR40-40-25CB	11 x 11	39.6 x 39.6 x 24.6	1.4	0.027
APR43-43-12CB	12 x 12	42.1 x 42.1 x 11.6	2.5	0.029
APR43-43-15CB	12 x 12	42.1 x 42.1 x 14.6	2.0	0.029
APR43-43-20CB	12 x 12	42.1 x 42.1 x 19.6	1.5	0.029
APR43-43-25CB	12 x 12	42.1 x 42.1 x 24.6	1.2	0.029

**MATERIAL:** 6063 Aluminum Alloy, Black Anodized

## FORGED COPPER HEAT SINKS WITH PIN FINS

### DESIGN FEATURES

- Precision forging technology for high power applications
- Omnidirectional pins
- Designed for BGA and other surface mount packages
- Various mounting methods available
- Select from multiple fin heights

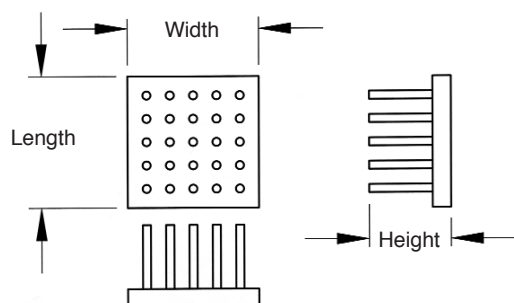
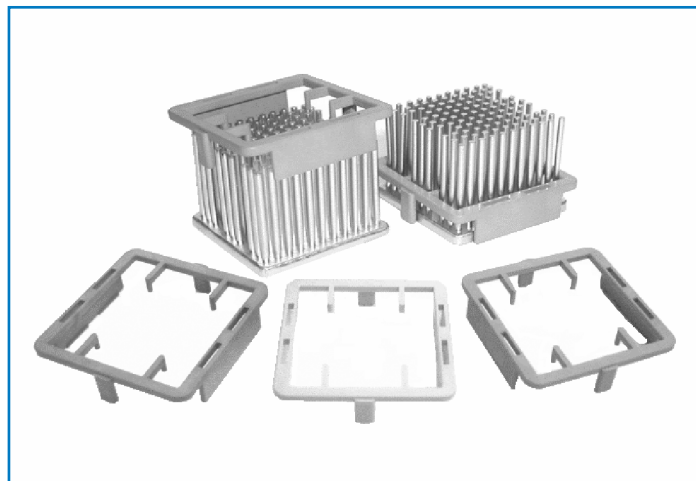

### PRODUCT BENEFITS

- No special tools needed for assembly
- No additional holes required on the PCB
- Special clip easily snaps on and self-aligns

### SERIES CPR FORGED COPPER HEAT SINKS WITH PIN FINS

Part Number	Fin Matrix (Rows x Columns)	Length x Width x Height (mm)	Thermal Resistance (°C/Watt @ 200 LFPM)	Pressure Drop (inches of water)
CPR19-19-12U	5 x 5	18.6 x 18.6 x 11.6	6.4	0.016
CPR19-19-15U	5 x 5	18.6 x 18.6 x 14.6	6.0	0.016
CPR19-19-20U	5 x 5	18.6 x 18.6 x 19.6	4.1	0.016
CPR19-19-25U	5 x 5	18.6 x 18.6 x 24.6	3.9	0.016
CPR27-27-12U	8 x 8	26.6 x 26.6 x 11.6	4.6	0.016
CPR27-27-15U	8 x 8	26.6 x 26.6 x 14.6	4.0	0.016
CPR27-27-20U	8 x 8	26.6 x 26.6 x 19.6	2.9	0.016
CPR27-27-25U	8 x 8	26.6 x 26.6 x 24.6	2.5	0.016
CPR29-29-12U	8 x 8	28.6 x 28.6 x 11.6	4.1	0.017
CPR29-29-15U	8 x 8	28.6 x 28.6 x 14.6	3.6	0.017
CPR29-29-20U	8 x 8	28.6 x 28.6 x 19.6	2.5	0.017
CPR29-29-25U	8 x 8	28.6 x 28.6 x 24.6	2.4	0.017
CPR33-33-12U	9 x 9	32.6 x 32.6 x 11.6	3.0	0.016
CPR33-33-15U	9 x 9	32.6 x 32.6 x 14.6	2.5	0.016
CPR33-33-20U	9 x 9	32.6 x 32.6 x 19.6	1.8	0.016
CPR33-33-25U	9 x 9	32.6 x 32.6 x 24.6	1.6	0.016
CPR35-35-12U	10 x 10	34.7 x 34.7 x 11.6	3.0	0.018
CPR35-35-15U	10 x 10	34.7 x 34.7 x 14.6	2.6	0.018
CPR35-35-20U	10 x 10	34.7 x 34.7 x 19.6	1.8	0.018
CPR35-35-25U	10 x 10	34.7 x 34.7 x 24.6	1.7	0.018
CPR38-38-12U	11 x 11	37.1 x 37.1 x 11.6	2.7	0.013
CPR38-38-15U	11 x 11	37.1 x 37.1 x 14.6	2.4	0.013
CPR38-38-20U	11 x 11	37.1 x 37.1 x 19.6	1.8	0.013
CPR38-38-25U	11 x 11	37.1 x 37.1 x 24.6	1.7	0.013
CPR40-40-12U	11 x 11	39.6 x 39.6 x 11.6	2.4	0.018
CPR40-40-15U	11 x 11	39.6 x 39.6 x 14.6	2.0	0.018
CPR40-40-20U	11 x 11	39.6 x 39.6 x 19.6	1.6	0.018
CPR40-40-25U	11 x 11	39.6 x 39.6 x 24.6	1.5	0.018
CPR43-43-12U	12 x 12	42.1 x 42.1 x 11.6	2.1	0.019
CPR43-43-15U	12 x 12	42.1 x 42.1 x 14.6	1.9	0.019
CPR43-43-20U	12 x 12	42.1 x 42.1 x 19.6	1.3	0.019
CPR43-43-25U	12 x 12	42.1 x 42.1 x 24.6	1.2	0.019

**MATERIAL:** Copper, CU1100

**CLIP STYLES**

**MATERIAL:** Nylon Plastic per UL94-V0

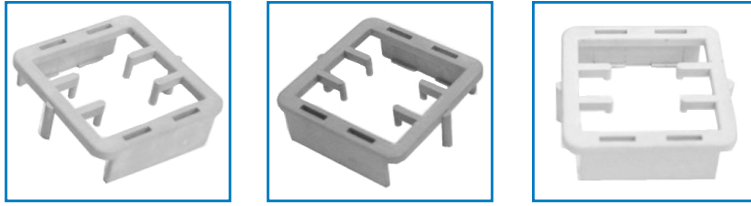

Component Size Length x Width (mm)	0.9mm +/- 0.3mm Short Height Color: Orange	1.7mm +/- 0.3mm Medium Height Color: Blue	3.3mm +/- 0.3mm Tall Height Color: Yellow	Clip Size Length x Width x Height (mm)
	Part Number			
19 x 19	C1919S	C1919M	C1919T	21.2 x 21.2 x 9.1
21 x 21	C2121S	C2121M	C2121T	23.2 x 23.7 x 9.1
23 x 23	C2323S	C2323M	C2323T	25.2 x 25.7 x 9.1
25 x 25	C2525S	C2525M	C2525T	27.2 x 27.7 x 9.1
27 x 27	C2727S	C2727M	C2727T	29.2 x 29.7 x 9.1
29 x 29	C2929S	C2929M	C2929T	31.2 x 31.2 x 9.1
31 x 31	C3131S	C3131M	C3131T	33.2 x 33.7 x 9.1
33 x 33	C3333S	C3333M	C3333T	35.2 x 35.2 x 9.1
35 x 35	C3535S	C3535M	C3535T	37.2 x 37.7 x 9.1
37.5 x 37.5	C3838S	C3838M	C3838T	39.7 x 40.2 x 9.1
40 x 40	C4040S	C4040M	C4040T	42.2 x 42.7 x 9.1
42.5 x 42.5	C4343S	C4343M	C4343T	44.7 x 45.1 x 9.1
45 x 45	C4545S	C4545M	C4545T	42.7 x 47.7 x 9.1

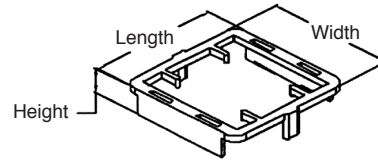

**TAPE STYLES**

Thermal Tape	Supplier	Thickness (mm)	Thermal Impedance (°C-in. <sup>2</sup> /W)	Dielectric Strength (V/mil)	Description
A01	CTS	0.13	0.82	4,000	Double-sided acrylic adhesive on a Kapton® MT carrier
T410	Chomerics	0.18	1.10	N/A	Double-sided acrylic adhesive loaded with aluminum oxide on an aluminum foil carrier
T411	Chomerics	0.28	1.00	N/A	Double-sided silicone adhesive with expanded aluminum mesh carrier
T412	Chomerics	0.23	0.25	N/A	Doubled-sided acrylic adhesive loaded with titanium diboride on an expanded aluminum carrier
8815	3M	0.38	1.20	668	Double-sided acrylic adhesive loaded with ceramic particles

**ORDERING INFORMATION**

**AER - 19-19-12 - CB - /A01**

Part Number Series

Dimensions in mm (LxWxH)

Mounting Options  
(Clip or Adhesive)

Commercial Black Anodize

**CLIP**

Short "/S"  
Medium "/M"  
Tall "/T"

**ADHESIVE**

Double-sided Kapton® "/A01"  
Chomerics Thermattach®  
"/T410, T411, or T412"  
3M™ "/8815"



**STANDARD AND CUSTOM EXTRUSIONS**

CTS specializes in using standard extrusion profiles and manufacturing custom products for your unique design. Our extruded heat sinks are designed for high power semiconductors and are ideal where cost is a factor. We provide special assistance with engineering, manufacturing and expedited deliveries to meet your specific requirements.

CTS maintains a large inventory of extrusions for custom designs. Modified profiles can be tooled quickly and cost-effectively. Below are just a few of the many profiles available. Please contact CTS for additional information.

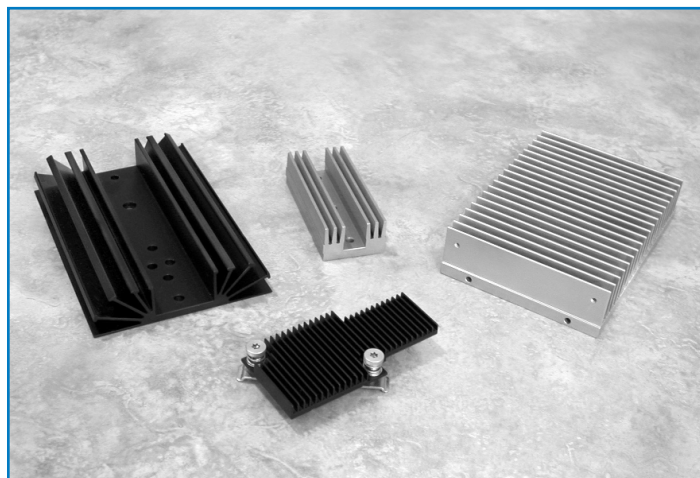

**CUSTOM EXTRUDED PRODUCTS AND STANDARD PROFILES**

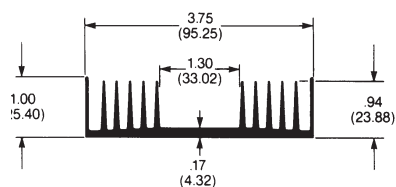

**E236**

**WT.** 1.5 lbs./ft. (2.28 kg./m.)  
**H.D.S.** 26.2 sq. in./in. (66.6 sq. cm./cm.)  
**T.R.** 2.0 °C/W

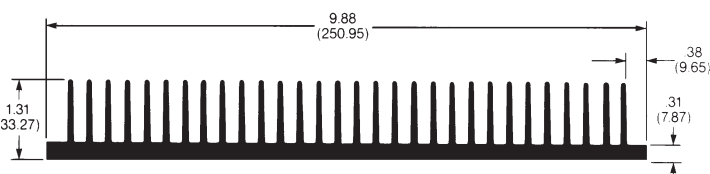

**E280**

**WT.** 6.20 lbs./ft. (9.22 kg./m.)  
**H.D.S.** 77.9 sq. in./in. (197.9 sq. cm./cm.)  
**T.R.** .9 °C/W

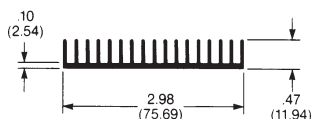

**E108**

**WT.** .76 lbs./ft. (1.13 kg./m.)  
**H.D.S.** 18.0 sq. in./in. (45.7 sq. cm./cm.)  
**T.R.** 2.6 °C/W

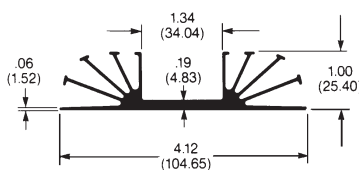

**E915**

**WT.** 1.3 lbs./ft. (1.86 kg./m.)  
**H.D.S.** 25.0 sq. in./in. (63.5 sq. cm./cm.)  
**T.R.** 2.1 °C/W

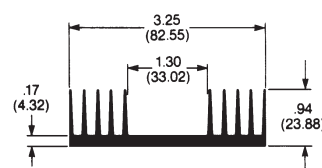

**E237**

**WT.** 1.3 lbs./ft. (1.95 kg./m.)  
**H.D.S.** 21.8 sq. in./in. (55.4 sq. cm./cm.)  
**T.R.** 2.3 °C/W

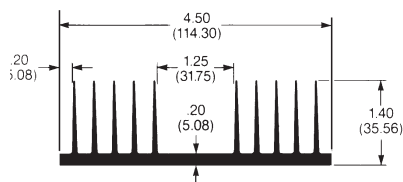

**E320**

**WT.** 2.2 lbs./ft. (3.23 kg./m.)  
**H.D.S.** 32.3 sq. in./in. (82.0 sq. cm./cm.)  
**T.R.** 1.8 °C/W

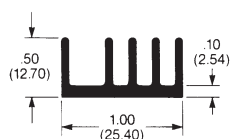

**E157**

**WT.** .32 lbs./ft. (.48 kg./m.)  
**H.D.S.** 6.1 sq. in./in. (15.4 sq. cm./cm.)  
**T.R.** 9.1 °C/W

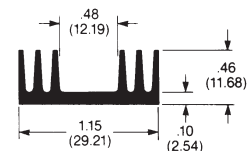

**E088**

**WT.** .23 lbs./ft. (.34 kg./m.)  
**H.D.S.** 6.8 sq. in./in. (17.2 sq. cm./cm.)  
**T.R.** 7.4 °C/W

**ADDITIONAL EXTRUDED PRODUCTS FOR TO-126, TO-202, TO-218 AND TO-220 TRANSISTORS**

**7-338 & 7-339-1, -2, -3, -4**

Tin-plated steel roll pins for solder mount

**Material ... 6063-T5 aluminum  
Finish ... Black Anodize**

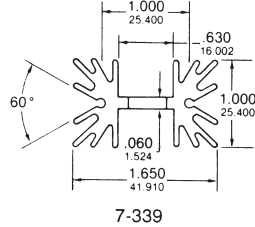
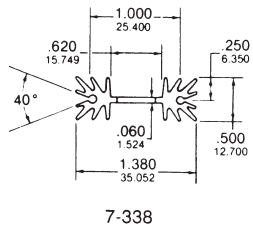
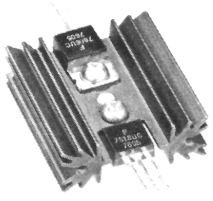
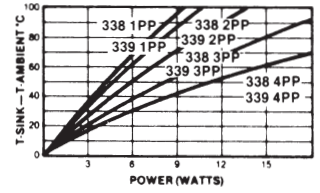

7-338

7-339

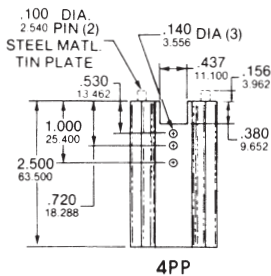

4PP

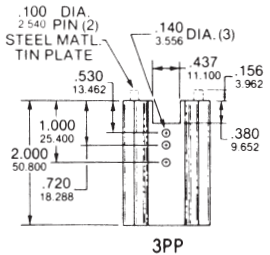

3PP

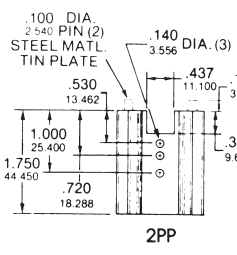

2PP

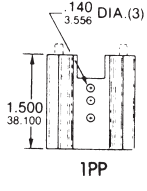

1PP

**7-340-1, -2, -3, -4**

**Material ... 6063-T5 Aluminum  
Finish ... Black Anodize**

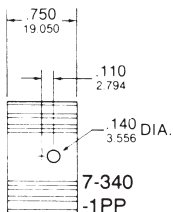
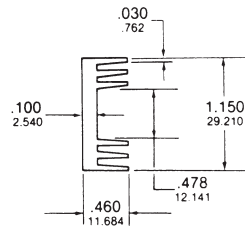
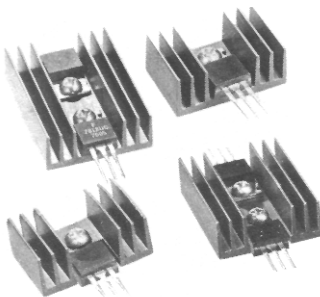
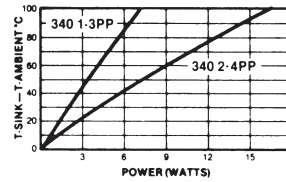

7-340 -1PP

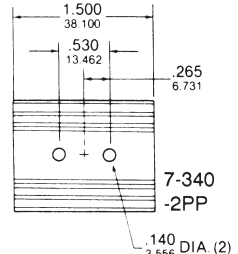

7-340 -2PP

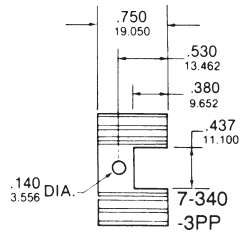

7-340 -3PP

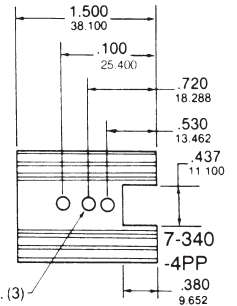

7-340 -4PP

**7-345-1, -2, -3, -4**

**Material ... 6063-T5 Aluminum  
Finish ... Black Anodize**

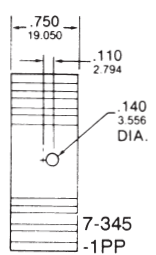
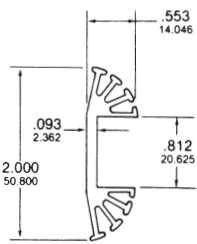
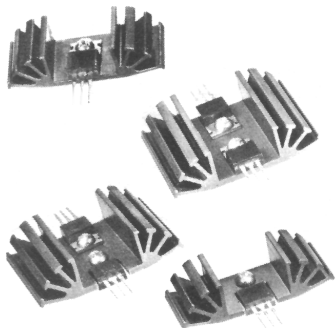
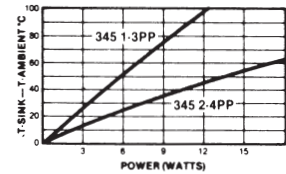

7-345 -1PP

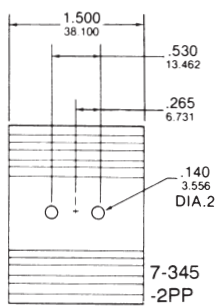

7-345 -2PP

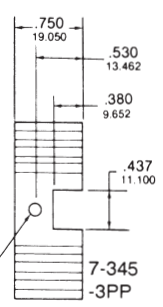

7-345 -3PP

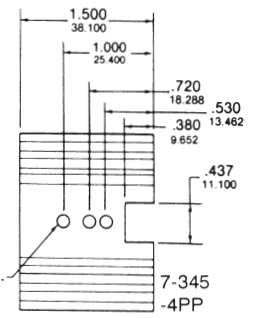

7-345 -4PP

## STANDARD ZIF CIRCUIT BOARD RETAINERS

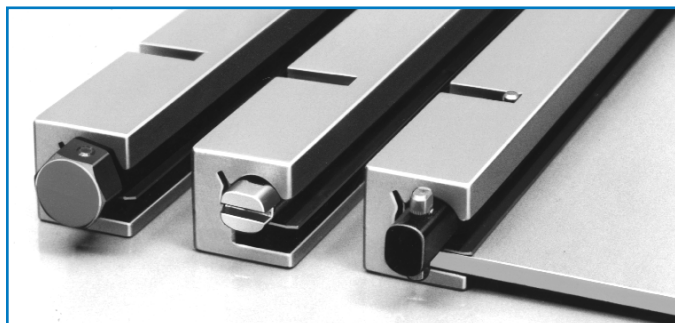

### THREE ZIF CONFIGURATIONS

- STANDARD ZIF (coldwall mounted)
- ZIF III (PCB mounted)
- MACHINED ZIF (ZIF geometry machined into coldwall)

### GENERAL DESCRIPTION

The ZIF retainer is a totally self-contained, precision assembly that provides a highly effective thermal interface between the circuit board and coldwall. Board lengths between 1-1/2” and 12” can be accommodated.

A ZIF retainer consists of:

- (1) an aluminum housing
- (2) a rod/cam assembly constructed from an aluminum or stainless steel double flat rod extrusion. The ZIF rod assembly is driven by one of three options: pin, hex-head or screwdriver slot
- (3) a beryllium copper spring

ZIF retainers are mounted to any flat metal surface (coldwall). The standard configuration is attached with 4-40 hardware. However, the retainer housing can be supplied

with tapped holes for M3x.5 metric hardware, or left undrilled with only index pins for vacuum brazing, dip brazing or epoxy bonding.

Engineers who specify the ZIF retainer can have confidence that it will perform as described. Complete product specifications are available upon request.

The following CTS laboratory test procedures, reports and results are available upon request:

- thermal performance testing
- shock testing
- vibration testing
- torque testing
- life cycling

### DESIGN FEATURES

#### ■ QUICK LOCKING ACTION

The locking operation which secures the PCB in the ZIF retainer requires only a 1/4 turn of the rod assembly.

#### ■ UNIFORM HEAT TRANSFER

Uniform clamping pressure eliminates hot spots along the PCB interface producing an even distribution of heat along the entire edge.

#### ■ COMPLETE INTERCHANGEABILITY

ZIF component parts are designed to assure consistent performance and interchangeability of all identical part numbers.

#### ■ OPERATING ENVIRONMENT

ZIF characteristics are unaffected by adverse environments typically encountered in military and industrial applications.

#### ■ VISUAL INDICATION

ZIF provides a visual indication that the rods are in the “open” or “closed” position relative to the position of the drive assembly.

#### ■ MAINTAINABILITY

The unique design and interchangeability of like parts make field repairs quick and simple. Repairs can be accomplished without the use of any special tools. Although ZIF retainers have been tested for over a thousand lock-unlock cycles, they have been derated and specified for 400 fully loaded cycles. This, in most cases, will exceed the overall system life, virtually eliminating service or maintenance to ZIF assemblies.

**SPECIFICATIONS**

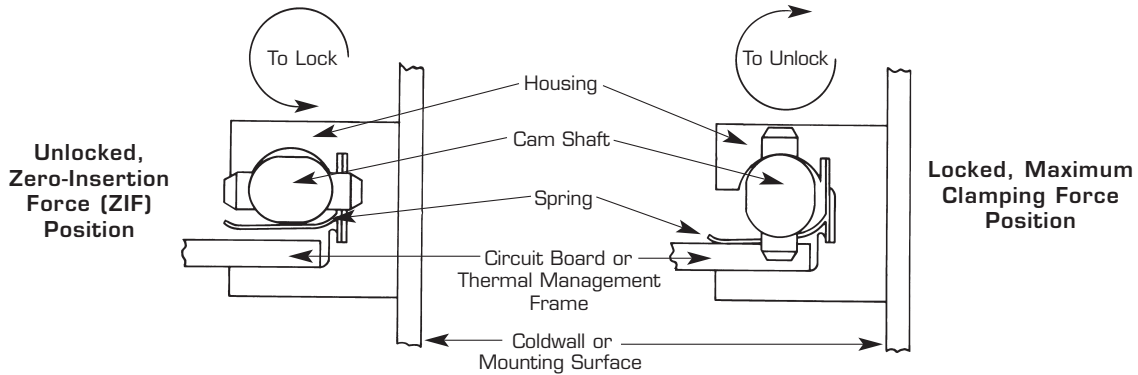

**ZIF OPERATION**

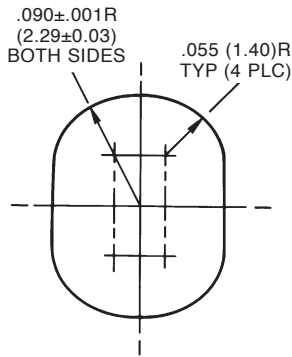

A positive mechanical detent is built into the cam rod shown here in cross section.

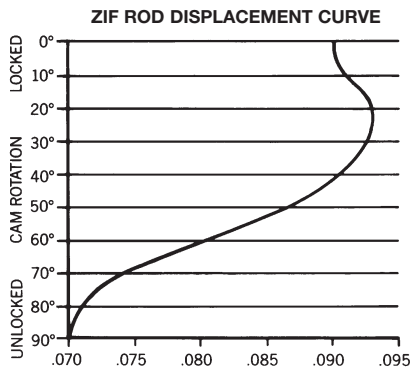

The ZIF cam detent design gives added assurance that a PCB will remain securely locked in position even under extreme vibration and shock levels. Detent action occurs during the final 15 degrees of cam rotation and virtually eliminates any possibility of the cam unlocking under environmental stress.

Improving the thermal conductivity of circuit board retainers enhances system performance by increasing the reliability of electronic components and circuit modules.

Extensive testing of ZIF retainers in the CTS Engineering Test Laboratory demonstrates that they have the best thermal performance of any circuit board retainer available.

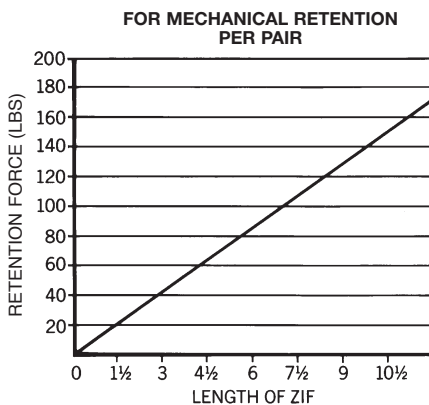
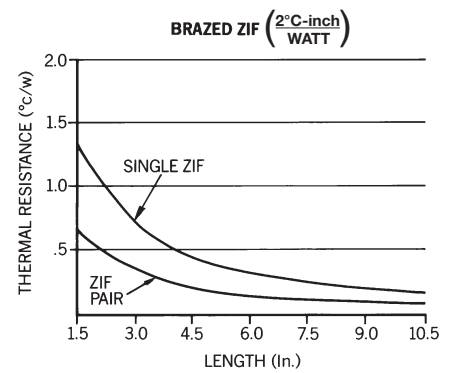
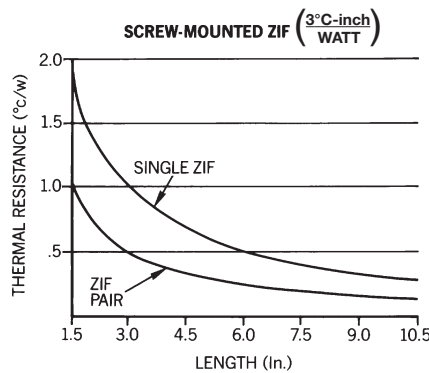

Clamping pressure is not only essential to heat transfer, but also a critical requirement for retention of PCBs under severe shock and vibration. ZIF retainers have been subjected to the most extreme test conditions specified in MIL-STD-810C.

Nominal retention force for a circuit board held captive by a pair of ZIF retainers (I/O connector excluded) is shown in the graph at the left.

**Technical Assistance for Custom Designs** - Our engineering staff has extensive experience in the packaging of ZIF retainers. Modification of standard housings, cams and spring configurations for special design applications is frequently possible. Contact the CTS factory in Burbank, California. We welcome the opportunity of providing you with the assistance needed to solve all of your thermal management problems.

**ORDERING INFORMATION**

**Z A S 1 1 1 - 062 - 15 R\* - B B U**

**ZIF Designation**  
**Assembly Option**  
 A=Assembled K=Kit  
**Mounting Method**  
 B=Brazed  
 S=Screws 4-40  
 M=Metric Screws (M3x0.5)  
**Housing Series**  
 1=Without Pins  
 2=With .062x.040  
 Extended Aluminum Index Pins  
**Rod Assembly**  
 1=Pin Drive, Aluminum Rod (6" Max.)  
 2=Pin Drive, Steel Rod  
 3=Slot Drive, Steel Rod (4.5" Max.)  
 4=1/4 Hex Drive, Aluminum Rod  
 7=3/16 Hex Drive, Steel Rod  
 ①S=3/16 Hex Drive, Steel Rod  
 ①Z=1/8" Socket Head Cap, Steel Rod  
**Spring Series**  
 1=Current Design  
**Board Thickness (±.005 Max.)**  
 .031" .050" .062" .084" .093" .125"

**Spring Plating**  
 U=Unplated  
 B=Black Cadmium  
 N=Nickel  
**Rod Plating**  
 B=Black Anod. Aluminum Rods  
 P=Passivated, Steel Rods  
**Housing Plating**  
 B=Black Anodize  
 U=Unplated  
 R=Chem. Film  
 R=Right Hand Part  
 L=Left Hand Part  
 Assembly Length in .5" Increments x 2  
 Ex: 7.5"=15

\*All assembled ZIFs must have a left or right designation.  
 Any kit with a 1/4 inch hexhead drive must have a left or right designation.

①Visual identification slot painted yellow.

**ROD STYLES**

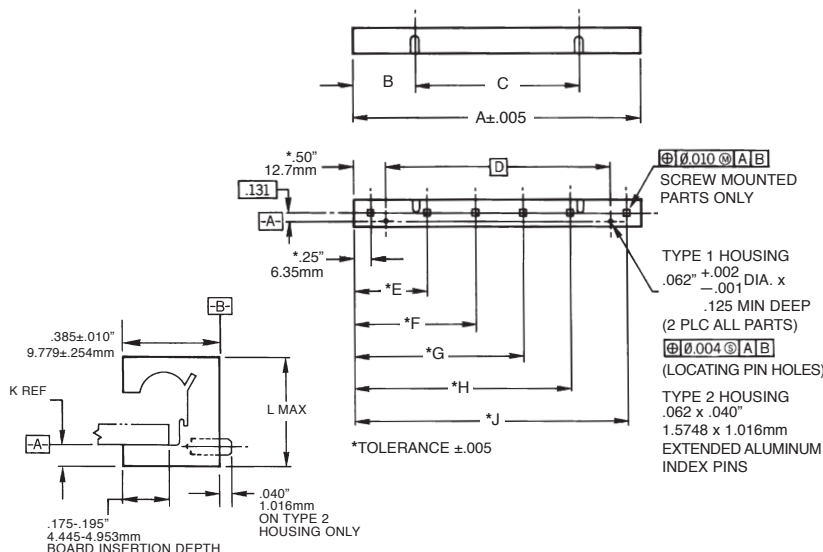
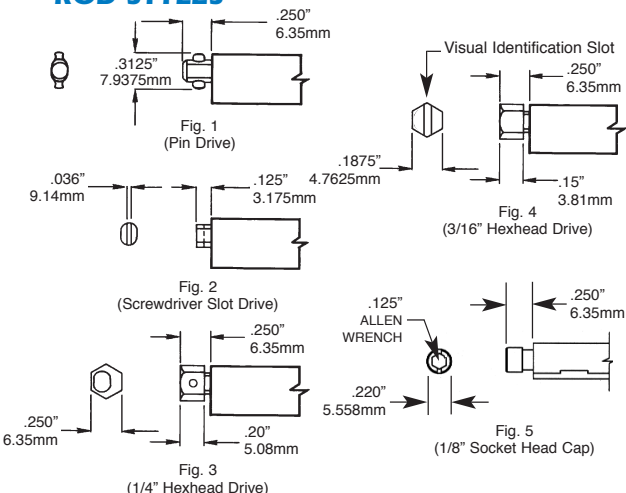

ROD TYPE			
DESIG.	FIG. NO.	MATERIAL	MAX. SPRING LENGTH
ZRA1	1	aluminum	6 inches
ZRA2	1	steel	10.5 inches
ZRA3	2	steel	4.5 inches
ZRA4	3	aluminum	10.5 inches
ZRA7	4	steel	10.5 inches
①ZRAS	4	steel	10.5 inches

ZIF circuit board retainers are available in several standard configurations. When ordering standard ZIF assemblies, kits or individual components, please refer to the ZIF identification number guide shown above. Custom ZIF retainers will be assigned special part number identification.

BOARD THICK	K REF	L MAX
.031"	.094"	.400"
.787mm	2.388mm	10.16mm
.050"	.075"	.400"
1.27mm	1.905mm	10.16mm
.062"	.063"	.400"
1.575mm	1.600mm	10.16mm
.084"	.063"	.422"
2.134mm	1.600mm	10.719mm
.093"	.079"	.447"
2.362mm	2.007mm	11.354mm
.125"	.082"	.478"
3.175mm	2.083mm	12.141mm

ZIF HOUSING DIMENSIONS											
LENGTH DESIGNATION	SPRING LENGTH	A ±.005	B	C	D	4-40 MOUNTING HOLES					NO. OF MNTG. HOLES
						E	F	G	H	J	
03	1.5	1.50	.75	—	.50	1.25	—	—	—	—	2
04	1.5	2.00	1.00	—	1.00	1.75	—	—	—	—	2
05	1.5	2.50	1.25	—	1.50	2.25	—	—	—	—	2
06	3	3.00	.75	1.5	2.00	1.50	2.75	—	—	—	3
07	3	3.50	1.00	1.5	2.50	1.75	3.25	—	—	—	3
08	3	4.00	1.25	1.5	3.00	2.00	3.75	—	—	—	3
09	4.5	4.50	.75	3.0	3.50	2.25	4.25	—	—	—	3
10	4.5	5.00	1.00	3.0	4.00	1.75	3.25	4.75	—	—	4
11	4.5	5.50	1.25	3.0	4.50	2.00	3.50	5.25	—	—	4
12	6	6.00	.75	4.5	5.00	2.00	4.00	5.75	—	—	4
13	6	6.50	1.00	4.5	5.50	2.25	4.25	6.25	—	—	4
14	6	7.00	1.25	4.5	6.00	2.50	4.50	6.75	—	—	4
15	7.5	7.50	2.25	3.0	6.50	2.00	3.75	5.50	7.25	—	5
16	7.5	8.00	2.50	3.0	7.00	2.00	4.00	6.00	7.25	—	5
17	7.5	8.50	2.75	3.0	7.50	2.25	4.25	6.25	8.25	—	5
18	9	9.00	3.75	1.5	8.00	2.50	4.50	6.50	8.75	—	5
19	9	9.50	4.00	1.5	8.50	2.00	3.75	5.75	7.50	9.25	6
20	9	10.00	4.25	1.5	9.00	2.00	4.00	6.00	8.00	9.75	6
21	10.5	10.50	5.25	—	9.50	2.25	4.25	6.25	8.25	10.25	6

All dimensions are in inches unless otherwise noted.

**ZIF III CIRCUIT BOARD RETAINERS**

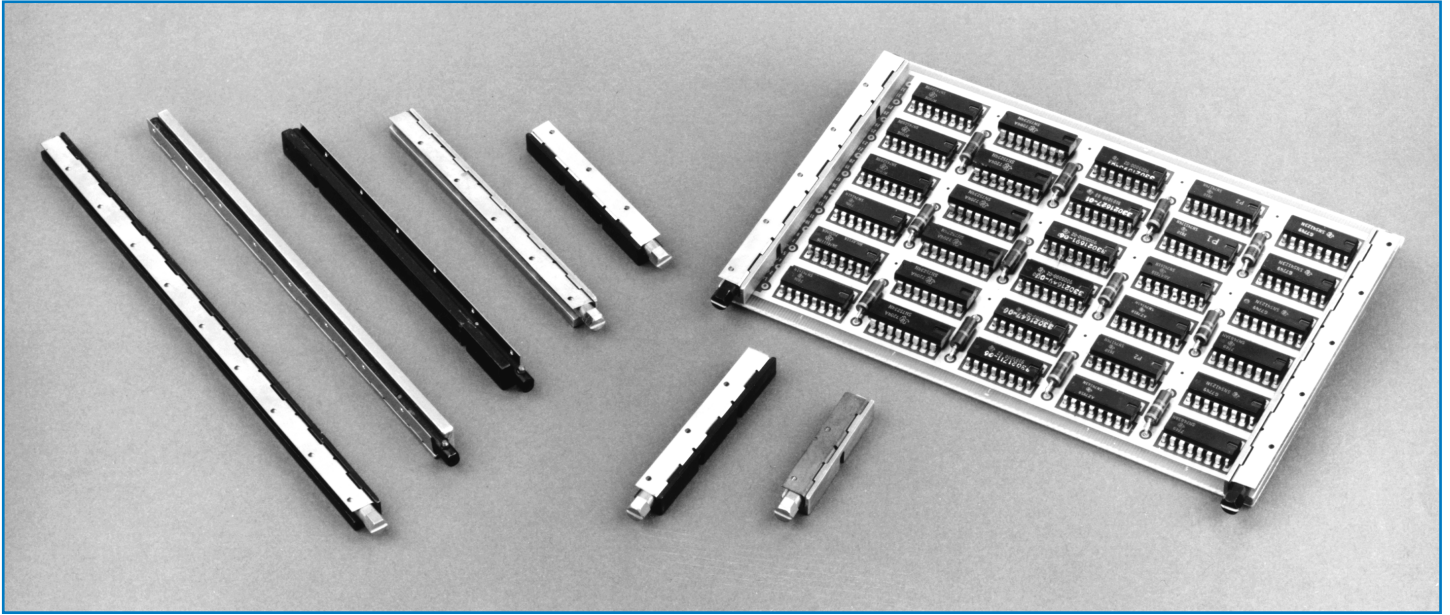

**GENERAL DESCRIPTION**

ZIF III retainers are the latest in the state-of-the-art PC board mountable retainers. Unlike other designs on the market, CTS's ZIF III features a quick, quarter-turn locking mechanism that provides for a positive and fast assembly. Its unique locking design produces a uniform pressure distribution along the PCB edge for the absolute best heat transfer and resistance to extreme shock and vibration. It will not warp your circuit boards unlike some others available in the market. If you have high density PC board mounting applications for military, space, medical, industrial controls, computers and communications, you need ZIF III Circuit Board Retainers.

**DESIGN FEATURES**

- **PC BOARD MOUNTABLE**
- **POSITIVE 1/4 TURN LOCKING**
- **FIELD MAINTAINABLE**
- **QUICK AND EASY INSTALLATION**
- **SUPERIOR MECHANICAL RETENTION**
- **THERMALLY EFFICIENT, 0.9 °C-INCH/WATT**

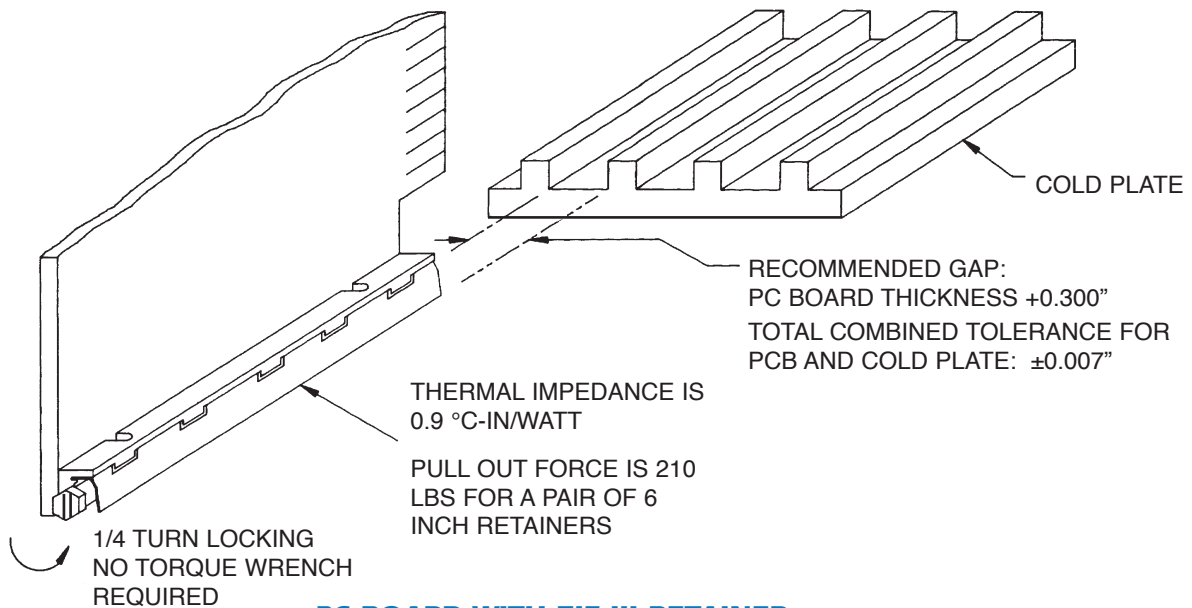

**PC BOARD WITH ZIF III RETAINER**

U.S. Patent No. 5,200,882

## ORDERING INFORMATION

Z 3 A 3 7 S B - 3 - B N L

### ZIF III DESIGNATION

### TOP ASSEMBLY OPTION

A=Assembled B=Kit

### LENGTH OF HOUSING ASSEMBLY

15=1.50 Inch  
 22=2.25 Inch  
 30=3.00 Inch  
 37=3.75 Inch  
 45=4.50 Inch  
 52=5.25 Inch  
 60=6.00 Inch  
 67=6.75 Inch  
 75=7.50 Inch

Consult factory for custom or longer lengths.

### MOUNTING TYPE

S=Screw Mounting (2-56)  
 B=No Holes  
 I=2-56 Helical Insert (Locking)  
 M=Screw Mounting (M3x.05)

### HOUSING FINISH

B=Black Anodize  
 U=Unplated  
 R=Chemical Film

R=Right Hand Part  
 L=Left Hand Part

### SPRING FINISH

U=Unplated  
 B=Black Cadmium  
 N=Nickel

### SPRING MATERIAL

B=Be Cu

### ROD TYPE

1=Pin Drive, Aluminum Rod  
 4.5" Max.  
 2=Pin Drive, Stainless Steel  
 3=Slot Drive, Stainless Steel  
 3.75" Max.  
 7=3/16 Hex Drive, Stainless Steel  
 S=Type 7 With Painted Indicator  
 Z=1/8" Socket Head Cap,  
 Stainless Steel Rod

## SPECIFICATIONS

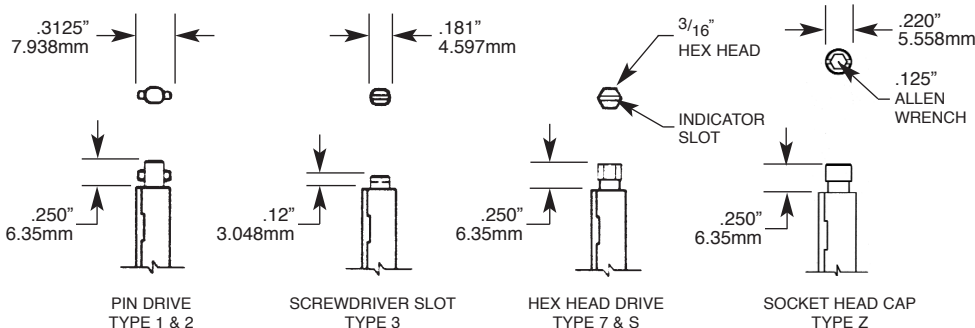
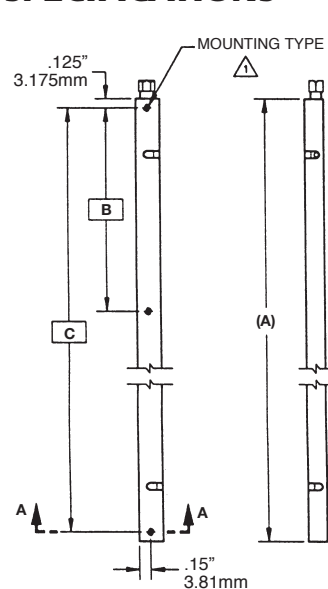

## ROD STYLES

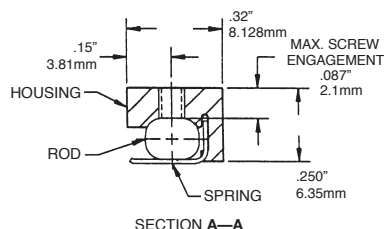
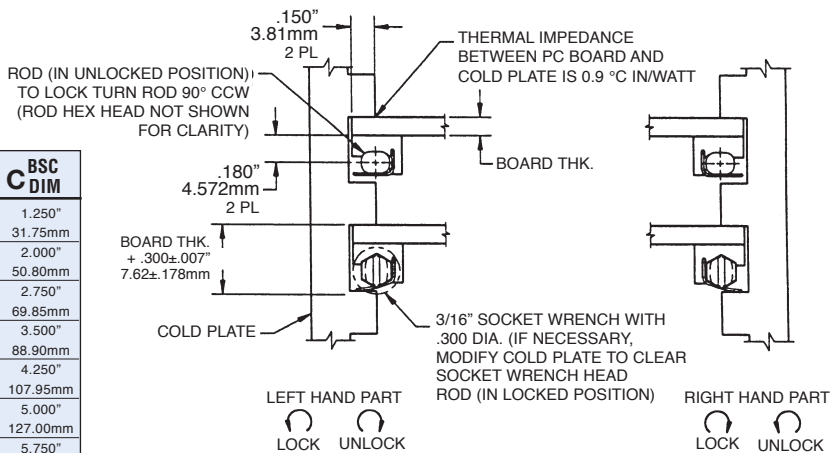

ADIM	BSC DIM	C DIM
1.500"	—	1.250"
38.10mm	—	31.75mm
2.250"	—	2.000"
57.15mm	—	50.80mm
3.000"	—	2.750"
76.20mm	—	69.85mm
3.750"	—	3.500"
95.25mm	—	88.90mm
4.500"	—	4.250"
114.30mm	—	107.95mm
5.250"	—	5.000"
133.35mm	—	127.00mm
6.000"	2.875"	5.750"
152.40mm	7.03mm	146.05mm
6.750"	3.250"	6.500"
171.45mm	82.55mm	165.10mm
7.500"	3.625"	7.250"
190.50mm	92.08mm	184.15mm

TOTAL WEIGHT PER ASSEMBLY:  
 ALUMINUM ROD 3.42 GRAM/IN.  
 STAINLESS STEEL 5.23 GRAM/IN.

Dimensions are for reference use only. Contact CTS for dimensions with tolerances or standard part drawings.

**MACHINED ZIF ENCLOSURES**

**GENERAL DESCRIPTION**

MACHINED ZIF represents a step forward in providing more design flexibility for military and industrial users of circuit board retainers. The ZIF retainer can now be machined directly into the chassis or coldwall without the need for brazing. This manufacturing breakthrough improves chassis producibility, adds structural integrity and provides the best thermal performance of any retainer available.

Fin pins can be machined to .012 inches with a pitch of 18 fins per inch without brazing. The MACHINED ZIF technology provides up to 45% more heat transfer capability than conventional wedge style retainers.

The MACHINED ZIF 1/4 turn locking feature enhances product maintainability and never requires a torque wrench when engaging.

*NOTE:*

*The photographs featured on this page are samples of one of many special configurations CTS can tailor make meeting customers' critical design specifications.*



**DESIGN FEATURES**

■ **QUICK LOCKING ACTION**

The locking operation that secures the PCB in the ZIF retainer requires only a 1/4 turn of the rod assembly.

■ **UNIFORM HEAT TRANSFER**

Uniform clamping pressure eliminates hot spots along the PCB interface producing an even distribution of heat along the entire edge.

■ **COMPLETE INTERCHANGEABILITY**

ZIF component parts are designed to assure consistent performance and interchangeability of all identical part numbers.

■ **OPERATING ENVIRONMENT**

MACHINED ZIF characteristics are unaffected by adverse environments typically encountered in military and industrial applications.

■ **VISUAL INDICATION**

ZIF provides a visual indication that the rods are in the “open” or “closed” position relative to the position of the drive assembly. This indication can be painted yellow upon request.

■ **MAINTAINABILITY**

The unique design and interchangeability of the like parts make field repairs quick and simple. Repairs can be accomplished without the use of any special tools.





**SPECIFICATIONS**

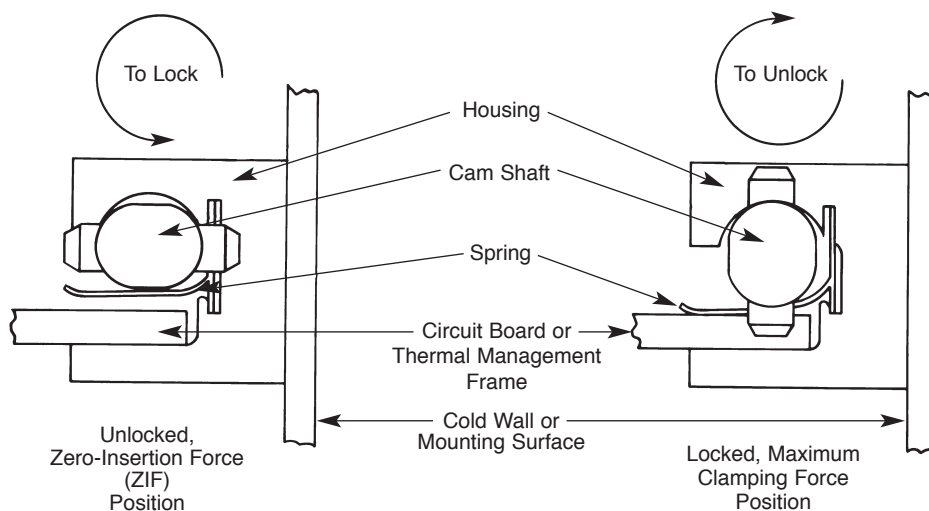

**ZIF OPERATION**

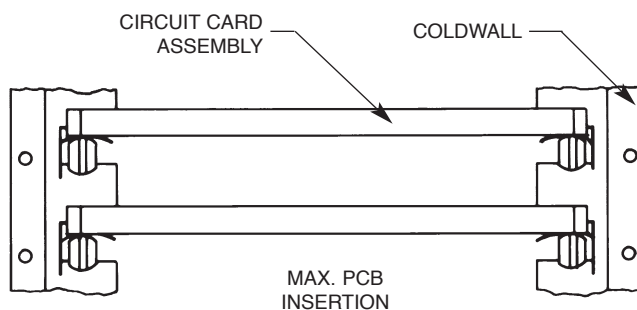

**COLDWALL CONFIGURATION**

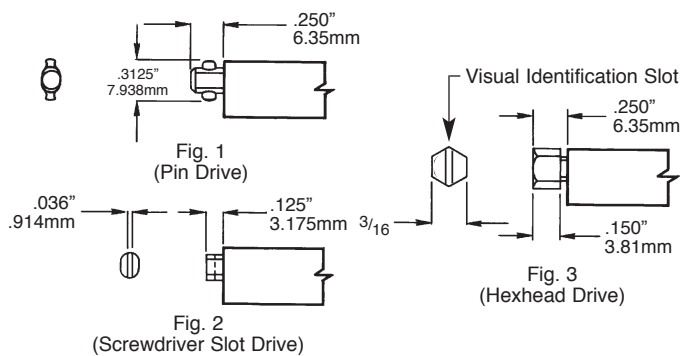

**ROD STYLES**

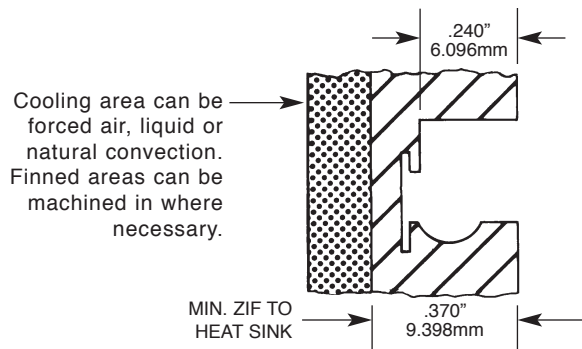

THERMAL IMPEDANCE:  
 Board to sink: 1.28°C-Inch/Watt  
 MINIMUM PCB SPACING (inches):  
 Center to center: .375" + PCB thickness  
 MINIMUM BOARD THICKNESS:  
 .050"

**ORDERING INFORMATION**

Machined ZIF Enclosures are custom designed to meet customer specifications. Please contact CTS

Applications Engineering Department in Burbank, California for technical assistance.

**iZIF™ HEAT FRAME**

**GENERAL DESCRIPTION**

The iZIF™ is a custom aluminum heat frame that integrates the PCB retainer for improved structural integrity and thermal efficiency (.8°C-in./W). The iZIF™ is a highly reliable patent-pending design for rugged military and aerospace circuit card applications. It features a quarter-turn lock, uniform clamping pressure, and can be sized to fit small daughter cards up to 9U VME. A bottom plate may also be added for additional cooling and structural integrity. The iZIF™ features a 1/8" stainless steel socket head cap rod with beryllium copper spring. A variety of finishes are available such as chemical film, black anodize, and electroless nickel.

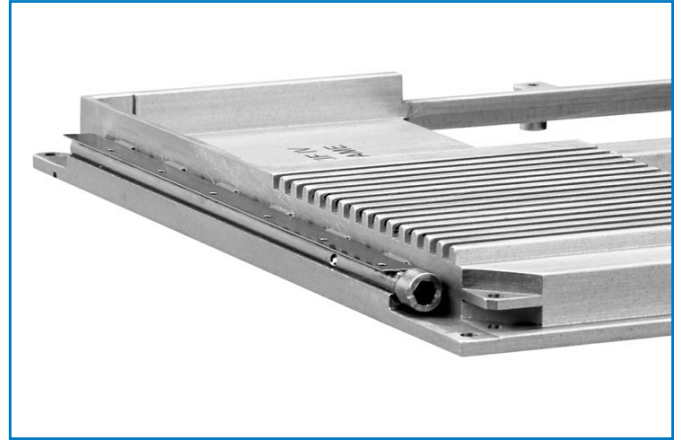

**THERMAL LINKS**

**GENERAL DESCRIPTION**

CTS's thermal links provide superior retention because of the 6 to 8-segment fingers versus the 2 or 3-segment fingers available from other manufacturers. These thermal links are offered for TO-5s, TO-8s and TO-18s with or without BeO washer and other appropriate hardware.

They provide an effective retainer and efficient thermal path between semiconductor and heat sinks or chassis.

There is excellent transistor retention under high vibration and shock loads. The thermal links can be inserted and removed multiple times without loss of retention or damage to the finish over the entire JEDEC case diameter range. They can be installed with a rivet or eyelet, soldered to a PC pad or heat sink, mounted with a single screw or with a threaded stud and hex nut.

**FAN TOP SERIES**

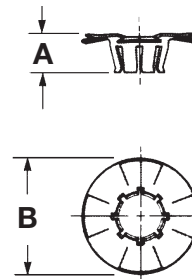
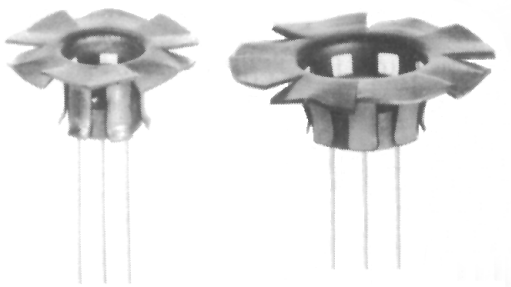

TXCF-032-025

**Fan Tops**

"A" Dim.	"B" Dim.	Semiconductor Case Type	*Ø °C/W	Part Number			Material
				Unplated	Black Cadmium	Black Chem.	
.25	.50	TO-18	150.0	TXBF-019-025U	TXBF-019-025B	N.A.	BeCu
.25	.50	TO-18	150.0	TXCF-019-025U	N.A.	TXCF-019-025CB	Brass
.25	.75	TO-5	81.1	TXBF-032-025U	TXBF-032-025B	N.A.	BeCu
.25	.75	TO-5	81.1	TXCF-032-025U	N.A.	TXCF-032-025CB	Brass
.36	1.25	TO-5	57.7	TXBF2-032-036U	TXBF2-032-036B	N.A.	Brass Fan BeCu Retainer
.33	1.25	TO-8	41.0	TXBF2-050-033U	TXBF2-050-033B	N.A.	Brass Fan BeCu Retainer
.12	1.25	TO-5	56.6	TXCF-125-1U	TXCF-125-1CB	N.A.	Brass
.12	1.25	TO-8	56.6	TXCF-125-2U	TXCF-125-2B	N.A.	Brass

\*Natural convection, case-ambient mounted on G10 board

## THERMAL LINKS FOR TO-5, TO-8 AND TO-18 TRANSISTORS

### Thermal Link Retainers Without BeO Insulators

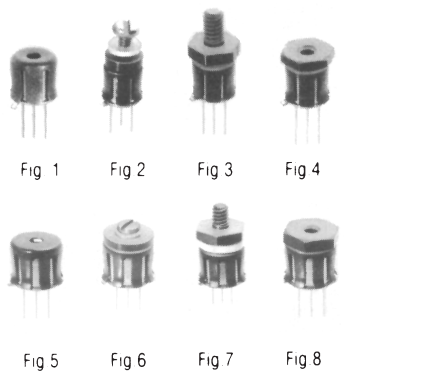
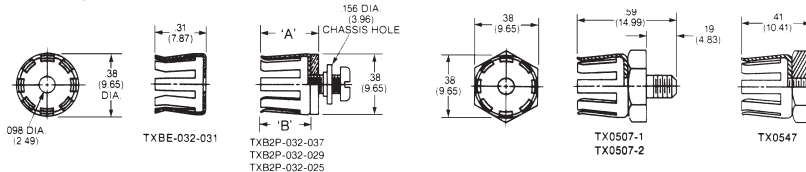

Fig. #	Semiconductor Case Type	Part Number		Mounting Method
		Black Cadmium Finish	Dull Nickel Finish	
1	TO-18	TXBE-019-021B	TXBE-019-021ND	Rivet/Solder
2	TO-18	TXB2P-019-028B	TXB2P-019-028ND	2-56 Screw
3	TO-18	TX1807B	TX1807ND	4-40 Stud
3	TO-18	TX1807-1B	TX1807-1ND	6-32 Stud
4	TO-18	TX1847B	TX1847ND	2-56 Hex Nut
5	TO-5	TXBE-032-031B	TXBE-032-031ND	Rivet/Solder
6	TO-5	TXB2P-032-037B	TXB2P-032-037ND	4-40 Screw
7	TO-5	TX0507-1B	TX0507-1ND	6-32 Stud
7	TO-5	TX0507-2B	TX0507-2ND	10-32 Stud
8	TO-5	TX0547B	TX0547ND	14-40 Hex Nut



Dimensions are for reference use only. Contact CTS for dimensions with tolerances or standard part drawings.

### Thermal Link Retainers With BeO Insulators

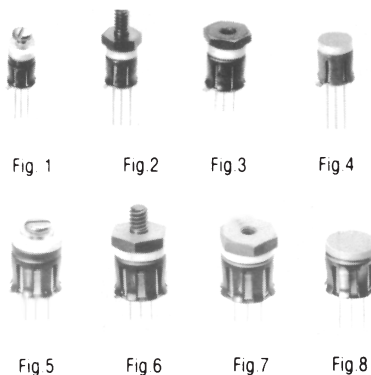
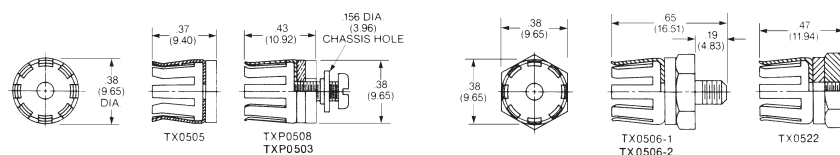

Fig. #	Semiconductor Case Type	Part Number		Mounting Method
		Black Cadmium Finish	Dull Nickel Finish	
1	TO-18	TXP1803B	TXP1803ND	2-56 Screw
1	TO-18**	TXP1808B	TXP1808ND	2-56 Screw
2	TO-18	TX1806B	TX1806ND	4-40 Stud
2	TO-18	TX1806-1B	TX1806-1ND	6-32 Stud
3	TO-18	TX1822B	TX1822ND	2-56 Hex Nut
4	TO-18	—	TX1805-ND	Solder
5	TO-5	TXP0503B	TXP0503ND	4-40 Screw
5	TO-5**	TXP0508B	TXP0508ND	4-40 Screw
6	TO-5	TX0506-1B	TX0506-1ND	6-32 Stud
6	TO-5	TX0506-2B	TX0506-2ND	10-32 Stud
7	TO-5	TX0522B	TX0522ND	4-40 Hex Nut
8	TO-5	—	TX0505-ND	Solder

\*\*BeO and thermal link are brazed together.



Dimensions are for reference use only. Contact CTS for dimensions with tolerances or standard part drawings.

## THERMAL LINKS FOR TO-8s

### Thermal Link Retainers Without BeO Insulators

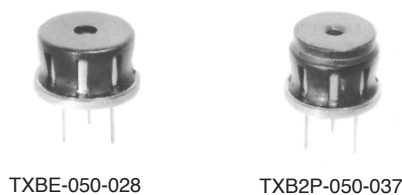

Part Number		Mounting Method	Max. Weight (Grams)	Case Diameter
Black Cadmium Finish	Dull Nickel Finish			
TXBE-045-028B	TXBE-045-028ND	Solder, Epoxy, Rivet	1.5	0.455
TXB2P-045-037B	TXB2P-045-037ND	4-40 Screw	4.5	0.455
TXBE-050-028B	TXBE-050-028ND	Solder, Epoxy, Rivet	1.5	0.500
TXB2P-050-037B	TXB2P-050-037ND	4-40 Screw	4.5	0.500
TXBE-055-028B	TXBE-055-028ND	Solder, Epoxy, Rivet	1.5	0.550
TXB2P-055-037B	TXB2P-055-037ND	4-40 Screw	4.5	0.550

Screw and shouldered nylon washer for .060 chassis included; If mounting hardware not desired, deleted "P" from part number.

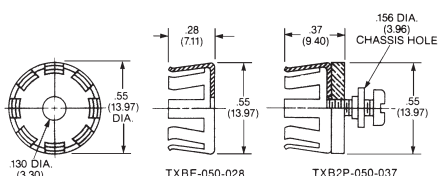

Dimensions are for reference use only. Contact CTS for dimensions with tolerances or standard part drawings.

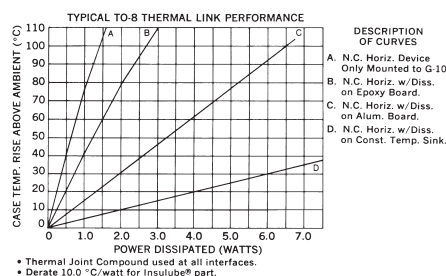

**HEAT SINKS FOR METAL AND PLASTIC CASE, CASE-MOUNTED SEMICONDUCTORS**

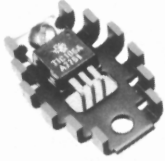
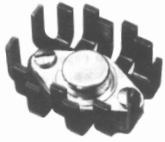

**LB Series**

Semiconductor Case Type	*Ø °C/W	Part Number			"A" Dim.
		Unplated	Comm'l Black	Military Black	
TO-66	19.7	LB66B2U	LB66B2CB	LB66N2B	.31
TO-126/127/220	20.8				
TO-66	17.1	LB66B1U	LB66B1CB	LB66B1B	.50
TO-126/127/220	16.5				

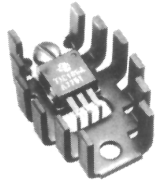
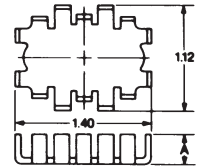

**LA-A Series**

Semiconductor Case Type	*Ø °C/W	Part Number			"A" Dim.
		Unplated	Comm'l Black	Military Black	
TO-66	19.7	LAD66A2U	LAD66A2CB	LAD66A2B	.50
TO-66	16.3	LAD66A3U	LAD66A3CB	LAD66A3B	.75
TO-66	14.4	LAD66A4U	LAD66A4CB	LAD66A4B	1.00
TO-126/127/220	20.0	LAE66A2U	LAE66A2CB	LAE66A2B	.50
TO-126/127/220	17.0	LAE66A3U	LAE66A3CB	LAE66A3B	.75
TO-126/127/220	14.7	LAE66A4U	LAE66A4CB	LAE66A4B	1.00

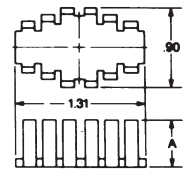

**LA-B Series**

Semiconductor Case Type	*Ø °C/W	Part Number			"A" Dim.
		Unplated	Comm'l Black	Military Black	
TO-66	14.3	LAD66B2U	LAD66B2CB	LAD66B2B	.50
TO-66	12.1	LAD66B3U	LAD66B3CB	LAD66B3B	.75
TO-66	10.7	LAD66B4U	LAD66B4CB	LAD66B4B	1.00
TO-66	9.8	LAD66B5U	LAD66B5CB	LAD66B5B	1.25
TO-3	14.1	LAT03B2U	LAT03B2CB	LAT03B2B	.50
TO-3	12.0	LAT03B3U	LAT03B3CB	LAT03B3B	.75
TO-3	10.3	LAT03B4U	LAT03B4CB	LAT03B4B	1.00
TO-3	9.3	LAT03B5U	LAT03B5CB	LAT03B5B	1.25
Any TO-3	15.3	LA363B2U	LA363B2CB	LA363B2B	.50
Any TO-3	12.9	LA363B3U	LA363B3CB	LA363B3B	.75
Any TO-3	11.2	LA363B4U	LA363B4CB	LA363B4B	1.00
Any TO-3	10.0	LA363B5U	LA363B5CB	LA363B5B	1.25
TO-126	15.0	LAT0126B2U	LAT0126B2CB	LAT0126B2B	.50
TO-126	12.9	LAT0126B3U	LAT0126B3CB	LAT0126B3B	.75
TO-126	11.4	LAT0126B4U	LAT0126B4CB	LAT0126B4B	1.00
TO-126	9.7	LAT0126B5U	LAT0126B5CB	LAT0126B5B	1.25
TO-127/220	15.0	LAT0127B2U	LAT0127B2CB	LAT0127B2B	.50
TO-127/220	12.9	LAT0127B3U	LAT0127B3CB	LAT0127B3B	.75
TO-127/220	11.4	LAT0127B4U	LAT0127B4CB	LAT0127B4B	1.00
TO-127/220	9.7	LAT0127B5U	LAT0127B5CB	LAT0127B5B	1.25
Universal Hole Pattern	—	LA394B2U	LA394B2CB	LA394B2B	.50
	—	LA394B3U	LA394B3CB	LA394B3B	.75
	—	LA394B4U	LA394B4CB	LA394B4B	1.00
	—	LA394B5U	LA394B5CB	LA394B5B	1.25

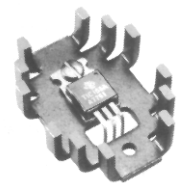
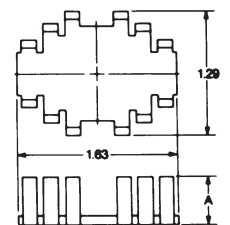

\*Natural convection, case-ambient mounted on G10 board

**UP3 Series**

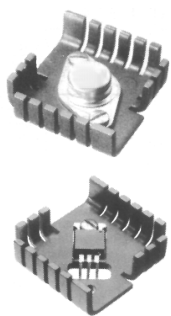

Semiconductor Case Type	*Ø °C/W	Part Number		
		Unplated	Comm'l Black	Military Black
TO-66	14.2	UP3-TO66-U	UP3-TO66-CB	UP3-TO66-B
TO-3	13.6	UP3-TO3-U	UP3-TO3-CB	UP3-TO3-B
Universal	—	UP3-425-U	UP3-425-CB	UP3-425-B
TO-126	15.0	UP3-TO126-U	UP3-TO126-CB	UP3-TO126-B
TO-127/220	15.0	UP3-TO127-U	UP3-TO127-CB	UP3-TO127-B
Universal	—	UP3-425-U	UP3-425-CB	UP3-425-B
2 each TO-126/127/220	13.6	UP3-456-U	UP3-456-CB	UP3-456-B

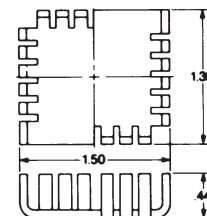

**UP10 Series**

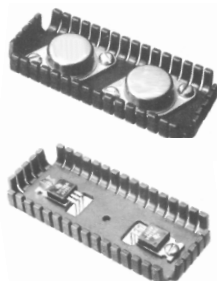

Semiconductor Case Type	*Ø °C/W	Part Number		
		Unplated	Comm'l Black	Military Black
2 each Universal	N.A.	UP10-426-2U	UP10-426-2CB	UP10-426-2B
1 each TO-3	8.7	UP10-TO3-U	UP10-TO3-CB	UP10-TO3-B
2 each TO-126/127/220	7.5	UP10-TO127-U	UP10-TO127-CB	UP10-TO127-B
Universal	N.A.	UP10-426-2U	UP10-426-2CB	UP10-426-2B

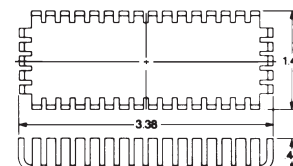

**UP, UP1 and UP2 Series**

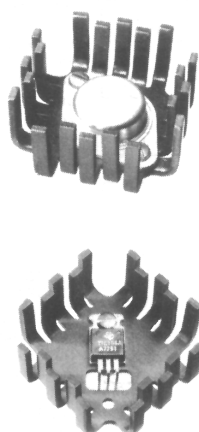

Semiconductor Case Type	*Ø °C/W	Part Number			"A" Dim.
		Unplated	Comm'l Black	Military Black	
TO-66	11.5	UP1-TO66-U	UP1-TO66-CB	UP1-TO66-B	.50
TO-66	9.6	UP2-TO66-U	UP2-TO66-CB	UP2-TO66-B	.75
TO-66	7.9	UP-TO66-U	UP-TO66-CB	UP-TO66-B	1.00
TO-3	10.4	UP1-TO3-U	UP1-TO3-CB	UP1-TO3-B	.50
TO-3	8.3	UP2-TO3-U	UP2-TO3-CB	UP2-TO3-B	.75
TO-3	7.1	UP-TO3-U	UP-TO3-CB	UP-TO3-B	1.00
Universal	—	UP1-420-U	UP1-420-CB	UP1-420-B	.50
Universal	—	UP2-420-U	UP2-420-CB	UP2-420-B	.75
Universal	—	UP-420-U	UP-420-CB	UP-420-B	1.00
TO-126	11.7	UP1-T0126-U	UP1-T0126-CB	UP1-T0126-B	.50
TO-126	9.4	UP2-T0126-U	UP2-T0126-CB	UP2-T0126-B	.75
TO-126	8.2	UP-T0126-U	UP-T0126-CB	UP-T0126-B	1.00
TO-127/220	11.7	UP1-T0127-U	UP1-T0127-CB	UP1-T0127-B	.50
TO-127/220	9.4	UP2-T0127-U	UP2-T0127-CB	UP2-T0127-B	.75
TO-127/220	8.2	UP-T0127-U	UP-T0127-CB	UP-T0127-B	1.00
2 each TO-126 or 2 each TO-127 or 2 each TO-220	10.7	UP1-T0127-2U	UP1-T0127-2CB	UP1-T0127-2B	.50
	8.3	UP2-T0127-2U	UP2-T0127-2CB	UP2-T0127-2B	.75
	7.4	UP-T0127-2U	UP-T0127-2CB	UP-T0127-2B	1.00

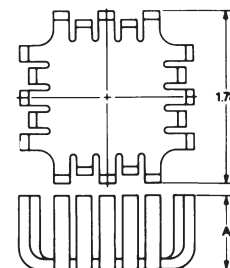

**HP1 Series**

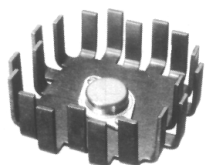

Semiconductor Case Type	*Ø °C/W	Part Number		
		Unplated	Comm'l Black	Military Black
TO-66	6.0	HP1-TO66-U	HP1-TO66-CB	HP1-TO66-B
TO-3	5.4	HP1-TO3-U	HP1-TO3-CB	HP1-TO3-B
Universal	—	HP1-420-U	HP1-420-CB	HP1-420-B
TO-126	6.5	HP1-TO126-U	HP1-TO126-CB	HP1-TO126-B
TO-127/220	6.5	HP1-TO127-U	HP1-TO127-CB	HP1-TO127-B
Dual TO-127/220	5.6	HP1-TO127-4U	HP1-TO127-4CB	HP1-TO127-4B

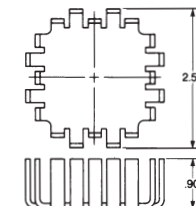

**HP3 Series**

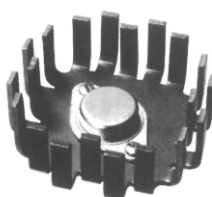

Semiconductor Case Type	*Ø °C/W	Part Number		
		Unplated	Comm'l Black	Military Black
TO-66	5.0	HP3-TO66-U	HP3-TO66-CB	HP3-TO66-B
TO-3	4.4	HP3-TO3-U	HP3-TO3-CB	HP3-TO3-B
Universal	—	HP3-420-U	HP3-420-CB	HP3-420-B
TO-126	5.0	HP3-TO126-U	HP3-TO126-CB	HP3-TO126-B
TO-127/220	5.0	HP3-TO127-U	HP3-TO127-CB	HP3-TO127-B
2 ea. TO-127/220	4.0	HP3-TO127-4U	HP3-TO127-4CB	HP3-TO127-4B
4 ea. TO-127/220	3.7	HP3-319-U	HP3-319-CB	HP3-319-B

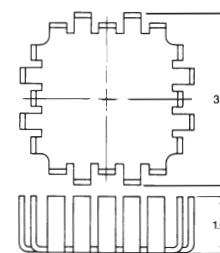

\*Natural convection, case-ambient mounted on G10 board

**BOARD-MOUNTED HEAT SINKS**

**PC Series**

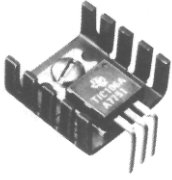

Semiconductor Case Type	*Ø °C/W	Part Number			"A" Dim.
		Unplated	Comm'l Black	Military Black	
TO-126/127/220	27.3	PC1-1U	PC1-1CB	PC1-1B	.38
TO-126/127/220	27.3	PC1-3U	PC1-3CB	PC1-3B	.38
TO-126/127/220	22.0	PC4-1U	PC4-1CB	PC4-1B	.75
TO-126/127/220	22.0	PC4-3U	PC4-3CB	PC4-3B	.75

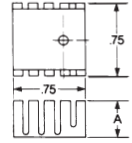

**PA Series**

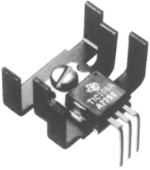

Semiconductor Case Type	*Ø °C/W	Part Number			"A" Dim.
		Unplated	Comm'l Black	Military Black	
TO-126/127/220	28.8	PA1-1U	PA1-1CB	PA1-1B	.50
TO-126/127/220	30.0	PA2-1U	PA2-1CB	PA2-1B	.31

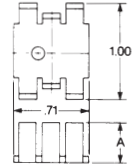

**PB Series**

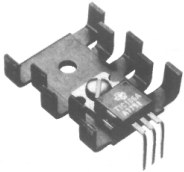

Semiconductor Case Type	*Ø °C/W	Part Number			"A" Dim.
		Unplated	Comm'l Black	Military Black	
TO-126/127/220	22.1	PB1-1U	PB1-1CB	PB1-1B	.50
Dual	—	PB1-2U	PB1-2CB	PB1-2B	.50
TO-126/127/220	25.0	PB2-1U	PB2-1CB	PB2-1B	.31
TO-126/127/220	—	PB2-2U	PB2-2CB	PB2-2B	.31

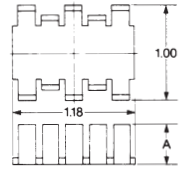

**PSC2 Series**

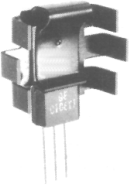

Semiconductor Case Type	*Ø °C/W	Part Number		
		Unplated	Comm'l Black	Military Black
TO-202	42.9	PSC2-1U	PSC2-1CB	PSC2-1B
TO-220	41.7	PSC2-2U	PSC2-2CB	PSC2-2B
Mota. 152	46.9	PSC2-3U	PSC2-3CB	PSC2-3B
TO-126	45.5	PSC2-4U	PSC2-4CB	PSC2-4B
TO-127	37.5	PSC2-5U	PSC2-5CB	PSC2-5B

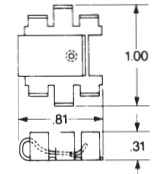

**VERTICALLY MOUNTED HEAT SINKS WITH BOARD-MOUNTED TABS**

**Vertical Tab Mounted Heat Sinks**

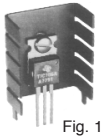

Fig. 1



Fig. 2

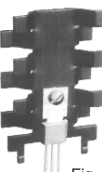

Fig. 3

Fig. #	Semiconductor Case Type	*Ø °C/W	Part Number			Black Anodize With Solder Tabs
			Unplated	Comm'l Black	Military Black	
1	TO-126/127/220	20.0	PB1-36U	PB1-36CB	PB1-36B	PB1ST-69CB
2	TO-126/127/220	25.9	PSB2-1U	PSB2-1CB	PSB2-1B	—
3	TO-202	17.6	PSD1-1U	PSD1-1CB	PSD1-1B	—
	TO-126/127/220	14.4	PSD1-2U	PSD1-2CB	PSD1-2B	—

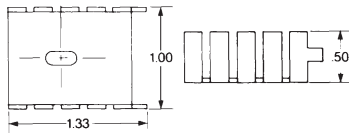

Fig. 1

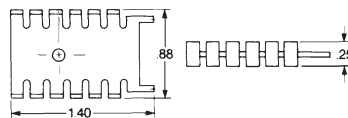

Fig. 2

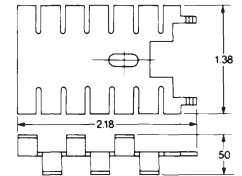
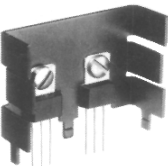
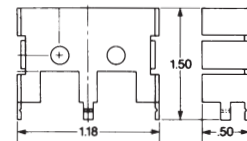

Fig. 3

**PSE1 Series**



Semiconductor Case Type	*Ø °C/W	Part Number		
		Unplated	Comm'l Black	Military Black
Mota. 152	17.1	PSE1-1U	PSE1-1CB	PSE1-1B
TO-126/127/220	15.0	PSE1-2U	PSE1-2CB	PSE1-2B
TO-202	17.4	PSE1-3U	PSE1-3CB	PSE1-3B



\*Natural convection, case-ambient mounted on G10 board

**BOARD AND VERTICALLY MOUNTED HEAT SINKS**

**7-192**

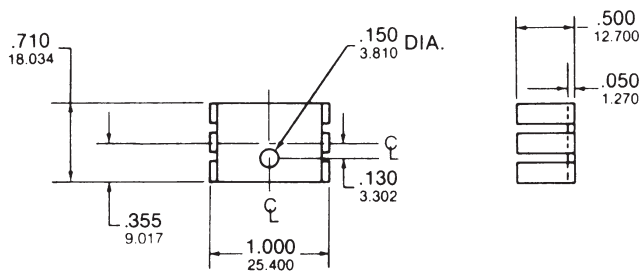
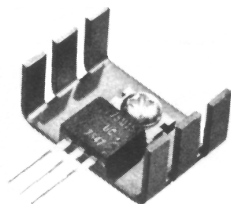

Material... 1100-H14 Aluminum  
Finish..... Black Anodize

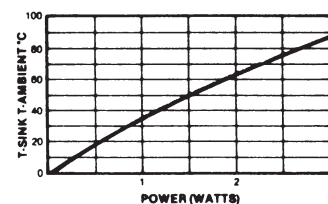

**7-195-1, -2**

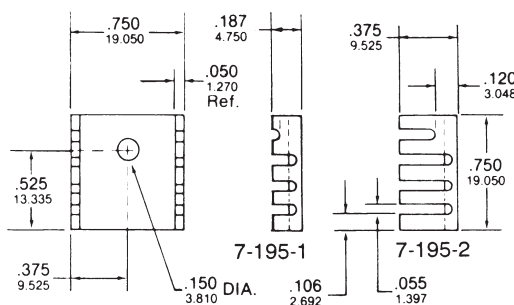
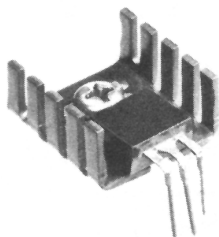

Material... 1100-H14 Aluminum  
Finish..... Black Anodize

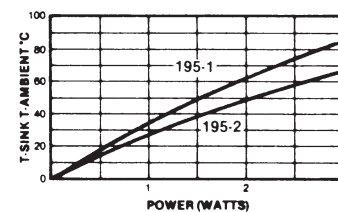

**7-363 & 7-364**

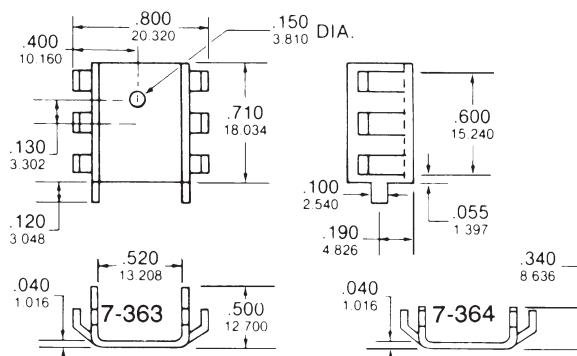
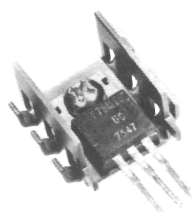

Material... 1100-H14 Aluminum  
Finish..... Black Anodize or  
Tin Plate

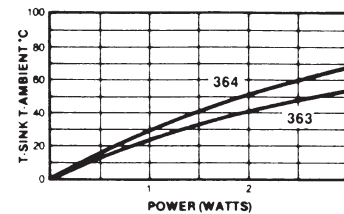

**7-370**

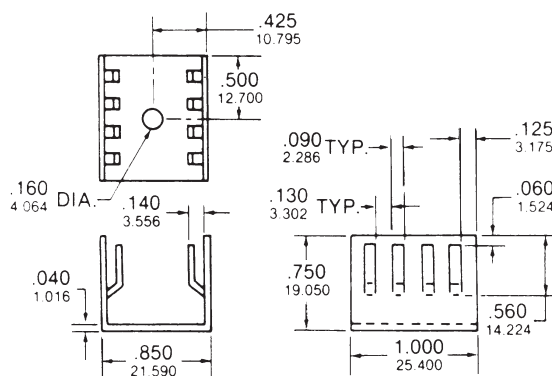
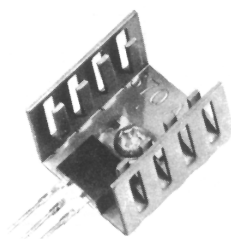

Material... 1100-H14 Aluminum  
Finish..... Black Anodize

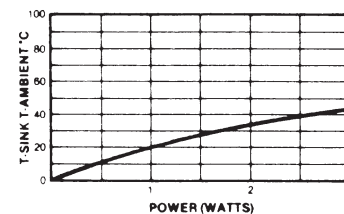



**CTS Electronic Components - California**

413 North Moss Street • Burbank, California 91502  
TEL: (818) 842-7277 • FAX: (818) 848-8872 • [www.ctscorp.com](http://www.ctscorp.com)